

FG-7000 Digital Force Gauge



Operation Manual



Warning

Operators should wear protection such as a mask and gloves in case pieces or components break away from the unit under test.

Whether the unit is ON or OFF, DO NOT exceed the capacity of the gauge. NEVER exceed 150% of the rated capacity, or the load cell will be damaged. At 110% of the rated capacity, the display will flash a warning.

When mounting FG-7000 Series Digital Force Gauges, use M4 mounting screws with a maximum insertion depth of 7 mm into the gauge. Hand tightens mounting screws, DO NOT use tools. Do not use damaged clamp.

Measure in line tension and compression forces only. DO NOT attempt to measure forces at an angle to the measuring shaft – damage to load cell and/or shaft may result.

Do not attempt to repair or alter this instrument. Warranty will be voided and damage to the unit may result.

Use and store within the stated temperature and humidity ranges, or damage and failure may result.

If not using this instrument for extended periods of time, remove the batteries to prevent potential battery leakage from causing product damage.

The new FG-7000 Series digital force gauges are loaded with functionality to simplify your compression and tension testing needs. Their robust housings are designed to fit perfectly in the hand for portable testing. The large backlit, 180° auto-reversible display, compression/tension icons, combined with the dual labeled key pad allows for instant switching from push to pull testing for portable or test stand applications.

The multiple-language FG-7000's provide menu programming for easy selection and set-up of the instrument to your desired requirements. Three modes of operation are selectable: Track mode for live readings, Peak mode for displaying the peak reading that remains until a higher peak is sensed, and Auto Peak mode which is similar to Peak mode except the peak on the display will additionally reset after a programmed time period. Programmable limits provide a quick visual and audible indication if a test passed or failed on the LCD. In addition, the comparator output can be set up for integration of the instrument into your quality system for repetitive testing such as on a production line.

These high-tech instruments can easily data log a reading at the push of a button for simple data acquisition, or be set to continuous data storage. Data can be viewed on the screen, sent to the optional printer, or loaded to be analyzed and graphed on the free software program. The 1,000 point memory with programmable groups allows for multiple tests to be recorded and easily separated upon loading.



SPECIFICATIONS

Accuracy: ± 0.2% F.S.

Selectable Units: mN, N, gf, kgf, ozf, and lbf. (Depending on Range)

Overload Capacity: 150% of F.S. (LCD flashes beyond 110% of F.S.)

Measurement method: Peak, Autopeak or Track Mode

Data Sampling Rate: 1000 Hz

Display: 160*128 dot matrix LCD with LED Backlight

Display Update Rate: 10 times/second

Resolution: (See 5.2 chart)

Memory: 1000 data

Set Point: Programmable high and low limits

Battery Indicator: Display flashes battery icon when battery is low

Power: 3.6VDC 800mAH Ni-MH rechargeable batteries

Battery Life: Approximately 16 hours continuous use per full charge

Charger / Adaptor: Universal USB/BM charger, Input: 110 ~ 240VAC

Temperature Effects: <0.054% per °F (0.03% FS per °C)

Outputs: RS-232; low limit and high limit outputs

Operating Temperature: 14 to 104°F (-10 to 40°C)

Storage Relative Humidity: 20 to 80%

Housing: Aluminum

Storage Temperature: -4 to 122°F (-20 to 50°C)

Oper. Relative Humidity: 5 to 95%

Dimensions: 5.7 x 2.9 x 1.4" (145 x 73 x 35.5 mm)

Product Weight: 1.5 lb (0.7 kg)

Package Weight: 2.8 lb (1.3 kg)

Warranty: 1 year

Certification: CE

Included Accessories: AC Adaptor/Charger, USB cable, calibration cert., 6 attachments: hook, flat tip, conical tip, chisel tip, notched tip, extension shaft.

LCD Screen



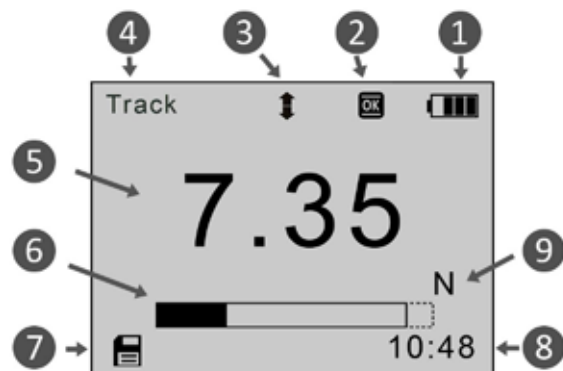

1. Battery icon: Battery level or charging status. Flashes when gauge needs to be recharged.
2. OK/OV Indicator: under lower limit; between low limit and upper limit; over upper limit
3. Force icon: Indicates force direction. means tension means compression
4. Test mode icon: Three measurement modes: Track, Peak and Auto Peak.
5. Current measured value
6. Analog bar: Indicates current position within full scale. When the bar enters the area enclosed by the dotted line, it means full scale capacity is exceeded and overload.
7. Storage icon: Indicates data is being saved.
8. System time
9. Units Indicator: Selected engineering unit.



NIDEC-SHIMPO CORPORATION

1.3 Key Functions

All keys are capacitive touch.

-  ON/OFF: Push for 2 seconds to power On or Off
-  During Measurement: Print the current force value or store data, depending on the key setting. (See 2.5.7 for key setting)
In Menu: Back or quit.
-  During Measurement: Enter the menus.
In Menu: Select or Enter
-  During Measurement: Track mode, tares weight of attachment. In Peak & Auto Peak modes, resets the peak value.
In Menu: Moves selection up or increases the value.
-  During Measurement: Changes the measure mode from Track, Peak or Auto Peak
In Menu: Moves selection down or decreases the value.

1.4 Modes

Track: Real time, live measuring mode.

Peak: Peak readings will not changed until a higher value is measured.

Auto Peak: When the Peak Time is up, resets the peak value automatically. (See 2.2.4 for Peak Time.)

2. ADVANCED MENU OPTIONS

2.1 Menu Structure

The FG-7000 Series Force Gauge has multi-level menu interface (Table 2-1) that enables simple navigation and programming.

Menu	Measurement	Unit
		Group
		Tolerance
		Test Mode
		Peak Time
		Alarm
		Storage Mode
	Memory	Browse All
		Browse Selected
		Delete Selected
		Delete All
		Print Recent
	Printing	Print Selected
		Print All
		Display Mode
	System	Power Off
		Backlight
		Key Tone
		Date/Time
		Password
		Key Setting
		Default Setting
		Language
		Calibration
Information		

Table 2-1

From the home screen, touch “MENU” to enter the main menu. (Figure 2-1)

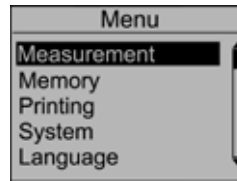

Figure 2-1a

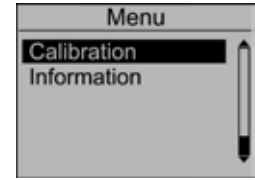

Figure 2-1b

2.2 Measurement

The Measurement menu contains six selectable items: Unit, Group, Tolerance, Peak Time and Alarm. (Figure 2-3)

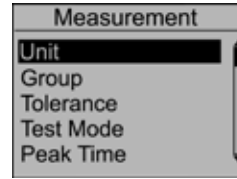

Figure 2-3a

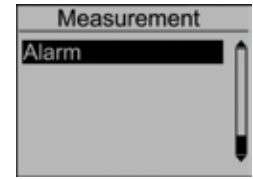

Figure 2-3b

2.2.1 Unit

The measuring unit can be selected under this menu. Different range models may have different unit selection capabilities. Touch “ZERO” or “MENU” keys to shift to the next selection. Press “LOG” to cancel or touch “MENU” to confirm and exit. (Figure 2-4)

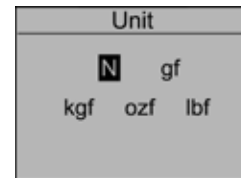

Figure 2-4

2.2.2 Group

When several test samples need to be measured, the samples can be coded into groups. The range is 01-99. When set to “00”, become, “01” automatically. Press “ZERO” to adjust the value, touch “MODE” to shift to the next position. Touch “LOG” to cancel; press “MENU” to confirm and exit. (Figure 2-5)

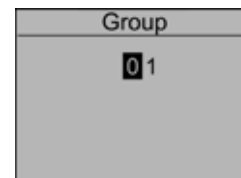

Figure 2-5

2.2.3 Tolerance

In the Tolerance menu, program high and low limit values to enable ok/ov testing. The lower limit value cannot be greater than the upper limit value, and neither limit value can be greater than 110% of the rated capacity. Press “ZERO” to adjust the value, touch “MODE” to shift to the next position. Press “LOG” to cancel; touch “MENU” to confirm and exit. (Figure 2-6)

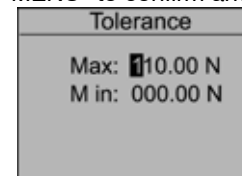

Figure 2-6

2.2.4 Test Mode

Change the mode of operation between three modes, press “ZERO” or “MODE” keys to select. Press “LOG” to cancel or “MENU” to confirm and exit. This adjustment can also be changed at home screen display by simply pressing “MODE”.

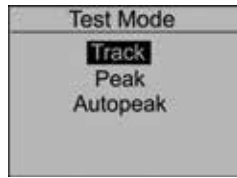

Figure 2-7

2.2.5 Peak Time

In the Peak Time menu, the peak auto reset time can be set. The range is 1-99 seconds. Touch “ZERO” to adjust the value, press “MODE” to shift to the next position. Press “LOG” to cancel; touch “MENU” to confirm and exit. (Figure 2-8)

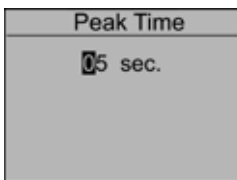

Figure 2-8

2.2.6 Alarm

The alarm function can be turned on or off. Touch “ZERO” or “MODE” keys to shift to the next position. Press “LOG” to cancel, touch “MENU” to confirm and exit. (Figure 2-9)

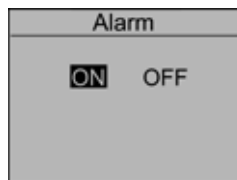

Figure 2-9

2.3 Memory

In the Memory menu, the user can select the mode of data storage, browse, delete, or print the data. (Figure 2-10)

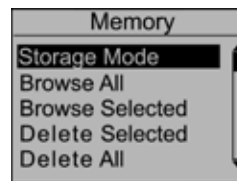

Figure 2-10

2.3.1 Storage Mode

Two storage modes can be selected in this menu: Single and Series. Touch “ZERO” or “MODE” keys to select between the two. Press “LOG” to cancel; touch “MENU” to confirm and exit. (Figure 2-11)

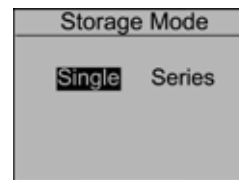

Figure 2-11

Single: At the home screen, pressing the “LOG” stores the current displayed value. (If the default settings key is for storage. See 2.5.7 key setting.)

Series: Continuous data logging will only operate while in the Auto Peak measuring mode. When the peak time has expired, unit stores the current displayed peak value and then resets the peak value on the display. Touch “LOG” to start, touch “LOG” again to end. (Figure 2-12)

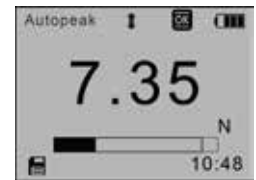

Figure 2-12

2.3.2 Browse All

The data will be displayed. Touch “ZERO” or “MODE” keys to shift to the next position. Touch “MENU” to see Delete or Print options. Touch “LOG” to go back. (Fig. 2-13)

- ① Position number
- ② Data and units
- ③ Force Direction
- ④ First Position Data

No.	Force	Dir
013	15.298 lbf	**
014	1.650 kgf	**
015	1.730 kgf	**
016	6.020 lbf	**

Figure 2-13

2.3.4 Browse Selected

User can choose the data to browse. The available range of data stored is shown. Touch “ZERO” to adjust the value. Press “MODE” to shift to the next position. Press “LOG” to cancel; touch “MENU” to confirm. (Figure 2-14)

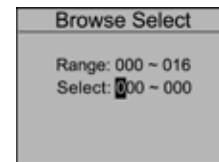

Figure 2-14

2.3.5 Delete Selected

Select the range of data to be deleted. Touch “ZERO” to adjust the value. Press “MODE” to shift to the next position. Touch “LOG” to cancel; touch “MENU” to confirm. (Figure 2-15)

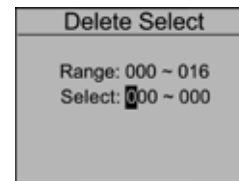

Figure 2-15

2.3.6 Delete All

In this menu, a prompt will appear. All data will be deleted by selecting “YES” and cancelled by selecting “NO” or pressing “LOG”. (Figure 2-16)

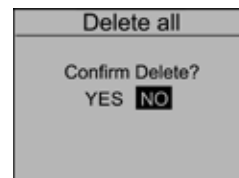

Figure 2-16

2.4 Printing

The Printing menu contains three selectable items: Print Recent, Print Selected and Print All. (Figure 2-17) The data saved in memory can be output to a printer through the serial port RS232 connection. (See 4.2.1 RS232 for more information) An example test report is shown in Figure 2-18.

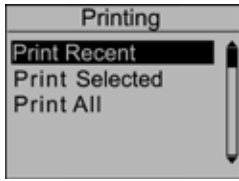

Figure 2-17

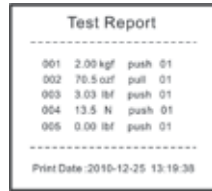

Figure 2-18

2.4.1 Print Recent

Print recently stored data in this menu. The range is 0~19. (Figure 2-19) Touch “ZERO” to adjust the value. Touch “MODE” to shift to the next position. Press “LOG” to cancel. Press “MENU” to confirm.

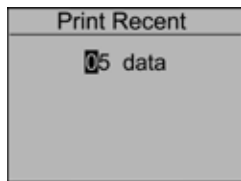

Figure 2-19

2.4.2 Print Selected

In this menu, select the data range to print. Touch “ZERO” to adjust the value, touch “MODE” to shift to the next position. Press “LOG” to cancel; touch “MENU” to confirm. (Figure 2-20)

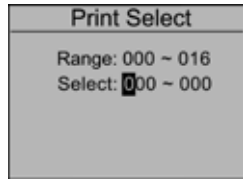

Figure 2-20

2.4.3 Print All

To print all data saved in memory, a prompt window will display. All data will be printed by selecting “YES”. This operation will be canceled by selecting “NO” or touching “LOG”. (Figure 2-21)

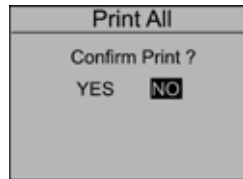

Figure 2-21

2.5 System

Under the System menu, several parameters may be set per Figure 2-22.

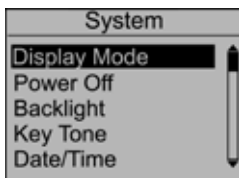

Figure 2-22a

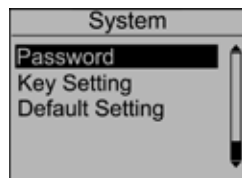

Figure 2-22b

2.5.1 Display Mode

Select the mode of the LCD display: Automatic, Obverse and Reverse. Touch “ZERO” or “MODE” keys to shift to the next position. Press “LOG” to cancel; Push “MENU” to confirm and exit. (Figure 2-23)

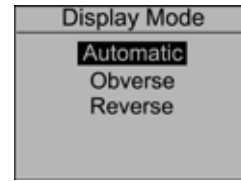

Figure 2-23

2.5.2 Power Off

To maximize battery life, the power can be set to shutdown after non-use. The time can be set in this menu. The range is 01-99 minutes. When set to “99” the gauge will never turn off. Touch “ZERO” to adjust the value, touch “MODE” to shift to the next position. Press “LOG” to cancel; Push “MENU” to confirm and exit. (Figure 2-24)

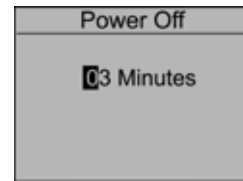

Figure 2-24

2.5.3 Backlight

Under this menu, the backlight can be set to ON, OFF or have an auto shutdown. Touch “ZERO” or “MODE” keys to shift to the next position. Press “LOG” to cancel. Press “MENU” to confirm and exit. (Figure 2-25)

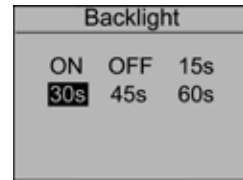

Figure 2-25

2.5.4 Key Tone

Turn the key sound ON or OFF. Touch “ZERO” or “MODE” keys to shift to the next position. Touch “LOG” to cancel; Press “MENU” to confirm and exit. (Figure 2-26)



Figure 2-26

2.5.5 Date/Time

The system time may be set under this menu. Touch “ZERO” to adjust the value. Press “MODE” to shift to the next position. Touch “LOG” to cancel. Press “MENU” to confirm and exit. (Figure 2-27)

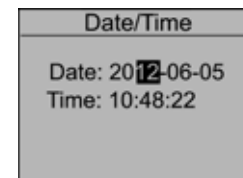

Figure 2-27

2.5.6 Password

The system password can be changed. First, enter the old password, then enter the new password and confirm the new password. The default System password is "123". Touch "ZERO" to adjust the value. Press "MODE" to shift to the next position. Touch "LOG" to cancel; Push "MENU" to confirm and exit. (Figure 2-28)

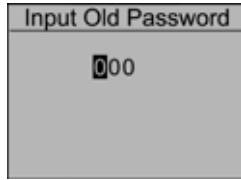

Figure 2-28

2.5.7 Key Setting

Set the default function of the "LOG" key from the home screen. The function can be set to print or store the current displayed value. Press "ZERO" or "MODE" to select the proper setting. Press "LOG" to cancel; touch "MENU" to confirm and exit. (Figure 2-29)

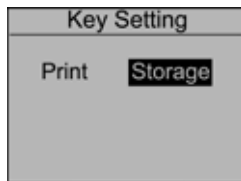

Figure 2-29

2.5.8 Default Setting

If you make a selection that you feel has caused the gauge to operate improperly, you can restore it to the factory default settings. Carefully use this function! (Figure 2-30)

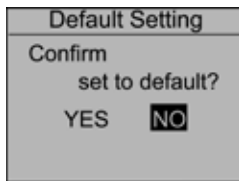

Figure 2-30

2.6 Calibration

Users can field-calibrate the gauge. First, enter the system password (Default is 123) by pressing the "ZERO" and "MODE" keys. Then press "MENU" to confirm. (Figure 2-31)

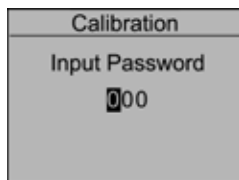

Figure 2-31

- ① Calibration Point
- ② Current Value
- ③ Standard Input Value

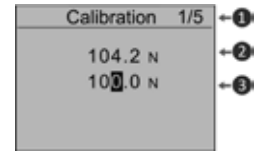

Figure 2-32

Load a standard force on the gauge. Wait a moment for the force to stabilize. The current value (2) should equal the standard force applied.

If the values do not match, press "ZERO" and "MODE" keys to correct the standard input value (3).

Press "MENU" to enter the next calibration point. After any of the calibration points have been completed, touch "LOG" to exit the calibration mode. Then save the calibration or discard by pressing "Yes" or "No".

After completing the calibration of the 5th point, the confirmation window will automatically ask to "Save and Exit" by selecting "Yes" or "No". (Figure 2-33)

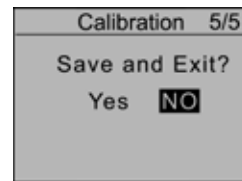

Figure 2-33

Press "ZERO" or "MODE" to select, then press "MENU". If "Yes" is selected, "Calibration Complete!" is displayed.

NOTE:

1. Ensure that the tare of attachment has been cleared before calibration.
2. For higher measuring precision throughout the test range, calibrating a point with a force at full scale is recommended.
3. Compression and tension calibrations are saved separately. The force gauge can identify the direction of the force, but each must be completed in a separate procedure.

2.7 Information

Information includes the model, version of the software and the serial number. (Figure 2-34)

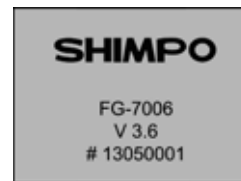

Figure 2-34

3. CHARGING

The FG-7000 Series Digital Force Gauge is supplied with a set of 3 Nickel Metal Hydride AAA rechargeable batteries, which are supplied fully charged to allow immediate use. Users need to recharge batteries when a low battery icon flashes. Users should connect the gauge and the charger using the USB cable. Then connect the charger to an AC socket to start charging. Laptops and other USB devices can also charge the gauge. A fully charged battery pack will provide approximately 16 hours of constant use.

Rechargeable battery pack:

- Type: Ni-MH 3.6VDC 800mAH rechargeable batteries
- Charging time: approx. 3~4 hours
- Battery life: approx. charge and discharge 500 times

4. COMMUNICATIONS

4.1 USB

The FG-7000 Series Digital Force Gauge is designed in accordance with USB2.0 standard protocol. (Figure 4.1) The USB can be connected to a charger with the USB cable for charging the internal Ni-MH battery and can be connected to a computer for uploading the measured values. Connect the gauge and the computer with the USB cable, then open the computer software. Upload the values. Please refer to the software manual for additional information.

4.2 Port Pin Assignments

PIN#	Definition
1	RS232-Transmit
2	RS232-Receive
3	RS232-Ground
4	Comparison Output B
5	Reserved
6	Comparison Output C
7	Comparison Output A
8	Reserved

Table 4-1



Figure 4-1

4.2.1 RS232

The RS232 serial port is used to connect a printer to print the memory data.

RS-232 specifications are as follows:

- Data transmission: serial interface
- Synchronization: asynchronous
- Signal Level: RS-232 level, logic 1:-5v, logic 0: +5v
- Hardware Flow Control: None
- Data word length: 8 bits
- Stop bit: 1bit
- Parity: None
- Baud rate: 38400

4.2.2 Comparison Output

Comparison Output internal circuit shown as Figure 4-3.

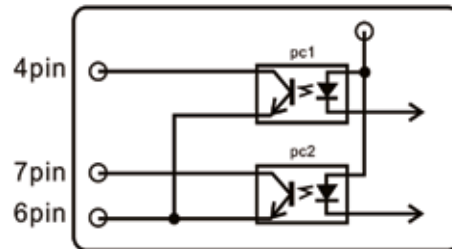
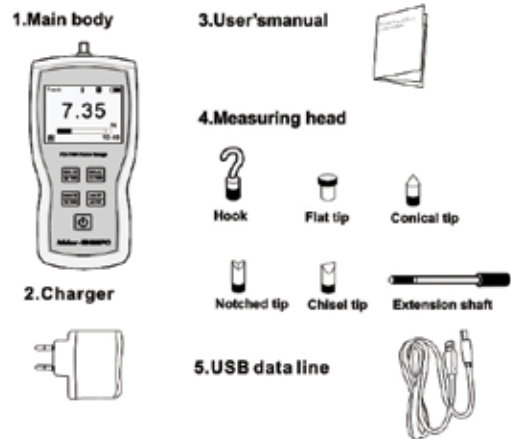

Figure 4-3

When the measured value is less than the lower limit tolerance value, the "pc2" operates, 7pin and 6pin line conduction. When the measured value is more than the upper limit tolerance value or 110% of the rated capacity, the "pc1" operates, 4pin and 6pin line conduction. Maximum permissible voltage: 7pin to 6pin, 4pin to 6pin 35V; 6pin to 7pin, 6pin to 4pin 6V.

5. MISC.

5.1 Accessories



5.2 Capacity and Resolution

Model		mN	N	gf	kgf	ozf	lbf
FG-7002	Capacity	5000.0	5.0000	500.00	-	18.000	1.1000
	Resolution	0.5	0.0005	0.05	-	0.005	0.0001
FG-7003	Capacity	10000	10.000	1000.0	1.0000	35.00	2.2000
	Resolution	1	0.001	0.1	0.0001	0.01	0.0005
FG-7004	Capacity	20000	20.000	2000.0	2.0000	70.00	4.400
	Resolution	5	0.005	0.5	0.0005	0.01	0.001
Fg-7005	Capacity	50000	50.000	5000.0	5.0000	180.00	11.000
	Resolution	5	0.005	0.5	0.0005	0.05	0.001
FG-7006	Capacity	-	100.00	10000	10.000	350.0	22.000
	Resolution	-	0.01	1	0.001	0.1	0.005
FG-7007	Capacity	-	200.00	20000	20.000	700.0	44.00
	Resolution	-	0.05	5	0.005	0.1	0.01
FG-7008	Capacity	-	500.00	50000	50.000	1800.0	110.00
	Resolution	-	0.05	5	0.005	0.5	0.01
FG-7009	Capacity	-	1000.0	-	100.00	3500	220.00
	Resolution	-	0.1	-	0.01	1	0.05

5.3 Diagram

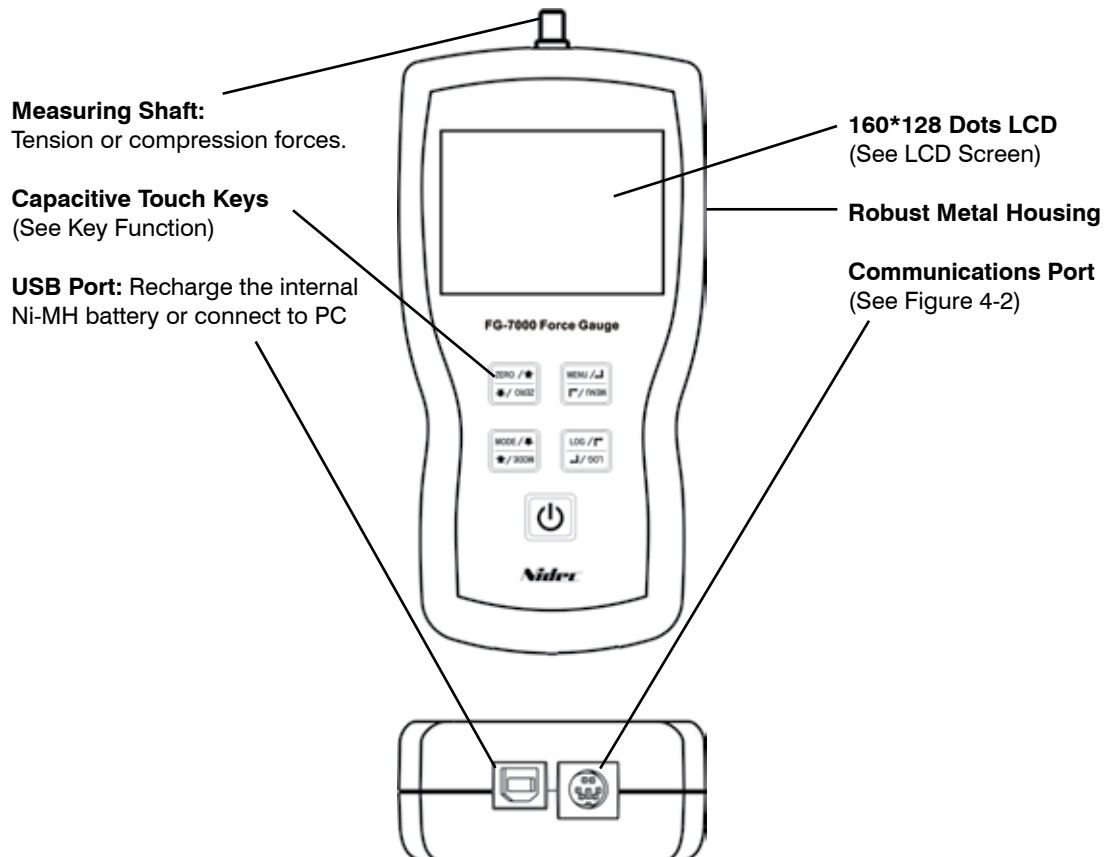

5.4 Dimensions

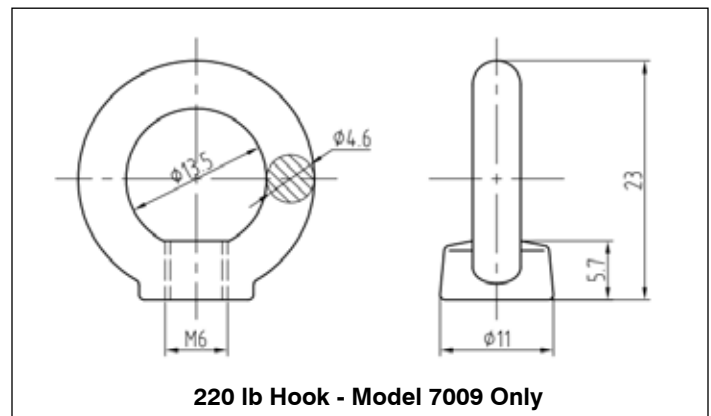
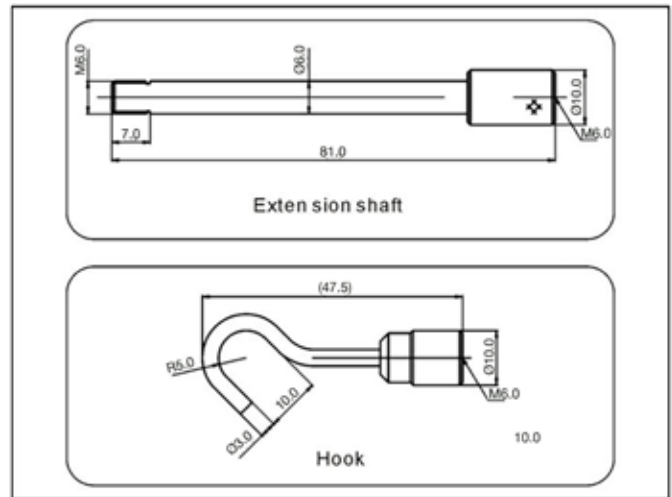
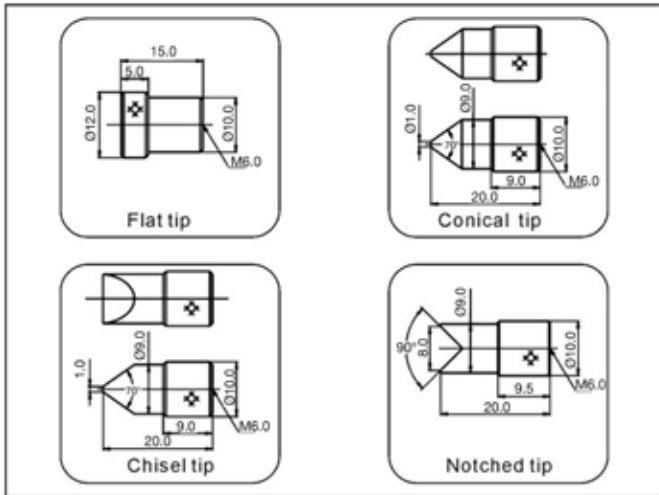
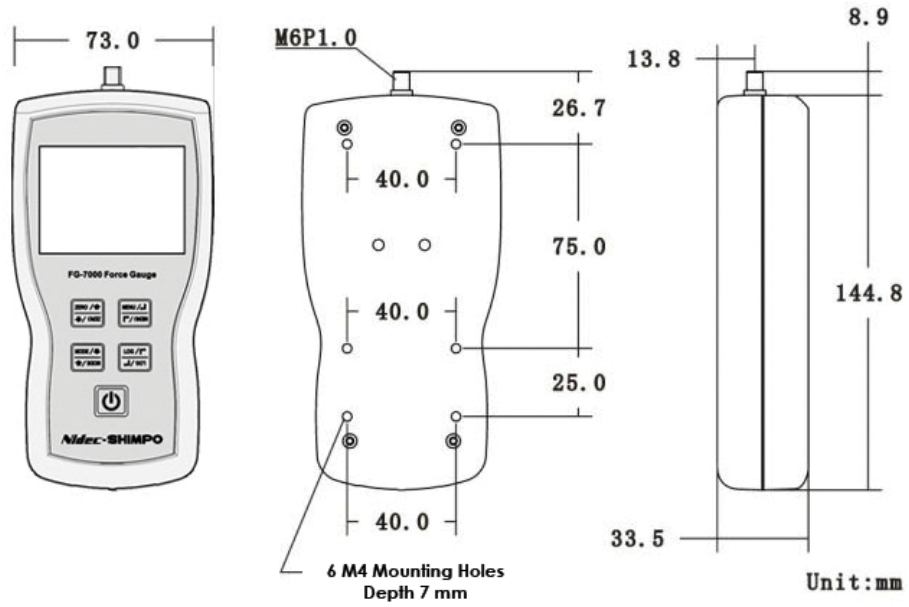

NIDEC-SHIMPO CORPORATION

INSTRUMENTS DIVISION • Phone: (800) 237-7079 • Fax: (630) 924-0342 • www.shimpoint.com