

## Operation Manual



### Warning

Operators should wear protection such as a mask and gloves in case pieces or components break away from the unit under test.

Whether the unit is ON or OFF, DO NOT exceed the capacity of the sensor. NEVER exceed 150% of the rated capacity for S beam, or 120% for ring type, or the load cell will be damaged. At 110% of the rated capacity the display will flash a warning.

When mounting FG-7000L Series Digital Force Gauges, use M4 mounting screws with a maximum insertion depth of 7 mm into the gauge. Hand tightens mounting screws, DO NOT use tools. Do not use damaged clamp.

Measure in line tension and compression forces only. DO NOT attempt to measure forces at an angle to the sensor – damage to load cell may result.

Do not attempt to repair or alter this instrument. Warranty will be voided and damage to the unit may result.

Use and store within the stated temperature and humidity ranges, or damage and failure may result.

If not using this instrument for extended periods of time, remove the batteries to prevent potential battery leakage from causing product damage.

DO NOT use tools to over torque the connection adapter. Hand-tighten only so damage does not occur.



The FG-7000L Series digital force gauges provide additional tension and compression testing flexibility with their external load cell input. External load cells are immediately recognized when connected to the display base. Three styles of load cells are available for your specific testing needs. The first is the 'S' Beam style load cell for both tension and compression tests with capacities ranging from 220 lbf (100 kgf) up to 4500 lbf (2000 kgf). The second style available is the 'Ring' type load cell for compression applications with capacities ranging from 2250 lbf (1000 kgf) all the way up to a hefty 44,000 lbf (200 kN). The third style is the "Mini Ring" type load cell for compression applications with capacities from 220 lbf (100 kgf) to 22 klbf (10,000 kgf).

The multiple-language FG-7000L's provide menu programming for easy selection and set-up of the instrument to your desired requirements. Four selectable modes of operation include: Track mode for live readings, Peak mode for displaying the maximum reading, Auto Peak where the peak resets after a programmed period of time and First Peak where only the initial peak is recorded once a decrease is sensed. The display has two selectable operations, numerical view with bar graph or graphical view with bar graph that if alarm tolerances are set, provides the user a quick view where their process is in relation to their upper and lower limit graph lines as well as pass/fail status.

These high-tech instruments can easily data log a reading at the push of a button for simple data acquisition, or be set to continuous data storage. Data can be viewed on the screen, sent to the optional printer, or loaded to be analyzed and graphed on the free software program. The 1,000 point memory with definable groups allows for multiple tests to be recorded and easily separated upon loading. In addition, the comparator output can be set up for integration of the instrument into a quality system for repetitive testing such as on a production line.

The FG-7000L's robust housings are designed to fit perfectly in the operator's hand for portable testing. The large back-lit, 180° auto-reversible display, compression/tension icons, combined with the dual labeled key pad allows for usage of the gauge in various positions while still being able to easily view and operate. These many features make the FG-7000L the ideal force instrument for various applications such as, incoming quality inspection, finished goods testing, R&D or almost any force testing requirement.

### SPECIFICATIONS

**Accuracy:**  $\pm 0.2\%$  F.S.

**Selectable Units:** kN, N, kgf, tf, lbf and klbf. (Depending on Range)

**Overload Capacity:** S beam: 150% of F.S.; Ring & Mini Ring Type 120% of F.S. (LCD flashes beyond 110% of F.S.)

**Measurement method:** Peak, Autopeak, First Peak or Track Mode

**Data Sampling Rate:** 1000 Hz

**Display:** 160\*128 dot matrix LCD with LED Backlight

**Display Update Rate:** 10 times/second

**Resolution:** (See page 2)

**Memory:** 1000 data

**Set Point:** Programmable high and low limits

**Battery Indicator:** Display flashes battery icon when battery is low

**Power:** 3.6VDC 800mAH Ni-MH rechargeable batteries

**Battery Life:** Approximately 16 hours continuous use per full charge

**Charger / Adapter:** Universal USB/BM charger, Input: 110 ~ 240VAC

**Temperature Effects:**  $<0.054\%$  per °F (0.03% FS per °C)

**Outputs:** USB, Serial Port RS-232, High & Low Limit NPN

**Operating Temperature:** 14 to 104°F (-10 to 40°C)

**Storage Relative Humidity:** 20 to 80%

**Housing:** Aluminum

**Storage Temperature:** -4 to 122°F (-20 to 50°C)

**Oper. Relative Humidity:** 5 to 95%

**Dimensions:** 5.7 x 2.9 x 1.4" (145 x 73 x 35.5 mm)

**Cable Length:** 9.8' (3 m)

**Product Weight:** 1.5 lb (0.7 kg)

**Package Weight:** 2.8 lb (1.3 kg)

**Warranty:** 1 year

**Certification:** CE

**Included Accessories:** AC Adapter/Charger, USB cable, calibration cert., carrying case

### LOAD CELL SPECIFICATIONS

**Zero Balance:**  $\pm 2\%$  F.S.

**Non-Linearity:** S Beam 0.03% F.S.; Ring Type 0.1% F.S., Mini Ring 0.5% F.S.

**Hysteresis:** S Beam 0.03% F.S.; Ring Type 0.1% F.S., Mini Ring 0.5% F.S.





**Temp. Effect:** S Beam 0.03%/10°C F.S.; Ring & Mini Ring Type 0.05%/10°C F.S.

**Overload Protection:** S Beam 150%; Ring & Mini Ring Type 120%

**Protection Class:** IP76



## 1. LCD SCREEN STANDARD VIEW

Test Mode Icons:

	Track: Real Time, live measuring mode
	Peak: Reading will not change until a higher value is measured
	AutoPeak: When Peak Time is up, resets peak value automatically
	First Peak: Captures First Peak after drop ratio decrease has been detected. Drop Ratio set in menus.

2. Battery icon: Battery level or charging status. Flashes when gauge needs to be recharged.

3. OK/OV Indicator:

	Under Lower Limit
	Between Low Limit & Upper Limit
	Over Upper Limit

4. Force Icons: Indicates force direction.

	Tension
	Compression

5. Current measured value

6. Analog bar: Indicates current position within full scale. When the bar enters the area enclosed by the dotted line, this signifies the full scale capacity is exceeded by an overload condition.

7. Storage icon: Indicates data is being saved.

8. System time

9. Units Indicator: Selected engineering unit.

10. Load Cell Capacity Icon:

	If no load cell is connected, this symbol appears & blinks
---	--

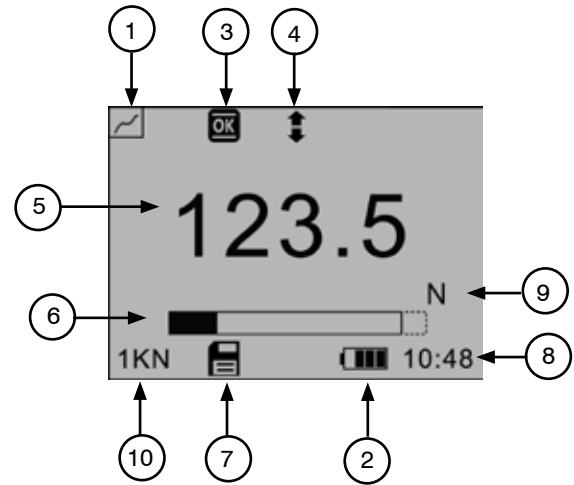

Digital View

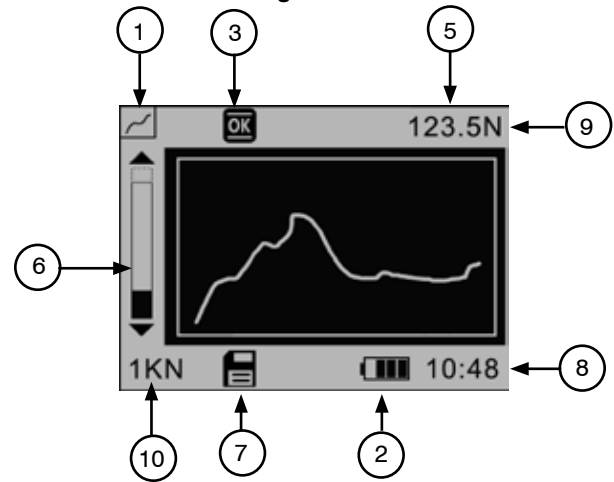

Graphic View

## 2. LOAD CELL CAPACITY & RESOLUTION TABLES

S-Beam: Compression or Tension Ring Styles: Compression Only		N	kgf	lbf	kN	klbf	tf
S-1 M-1	Capacity	1000	100	220	-	-	-
	Resolution	0.1	0.01	0.05	-	-	-
S-2	Capacity	2000	200	450	-	-	-
	Resolution	0.5	0.05	0.1	-	-	-
S-5 M-5	Capacity	5000	500	1100	-	-	-
	Resolution	1	0.1	0.1	-	-	-
S-10 R-10 M-10	Capacity	10000	1000	2250	10	-	-
	Resolution	1	0.1	0.5	0.01	-	-
S-20 R-20	Capacity	-	2000	4500	20	-	-
	Resolution	-	0.5	1	0.005	-	-
R-50 M-50	Capacity	-	5000	-	50	11	5
	Resolution	-	0.5	-	0.005	0.001	0.0005
R-100 M-100	Capacity	-	-	-	100	22	10
	Resolution	-	-	-	0.01	0.005	0.001
R-200	Capacity	-	-	-	200	44	20
	Resolution	-	-	-	0.05	0.01	0.005

### 3. KEY FUNCTIONS

All keys are capacitive touch.

- 

ON/OFF: Push for 2 seconds to power On or Off
- 

During Measurement: Print the current force value or store data, depending on the key setting. (See 4.5.8 for key setting)  
In Menus: Back or quit.
- 

During Measurement: Enter the menus.  
In Menus: Select or Enter
- 

During Measurement: Track mode, tares weight of attachment. In Peak & Auto Peak modes, resets the peak value.  
In Menus: Moves selection up or increases the value.
- 

During Measurement: Changes the measure mode from Track, Peak, Auto Peak, First Peak  
In Menus: Moves selection down or decreases the value.

### 4. ADVANCED MENU OPTIONS

#### 4.1 Menu Structure

Menu	Measurement	Unit
		Group
		Tolerance
		Test Mode
		Peak Time
		Alarm
		Storage Mode
	Memory	Browse All
		Browse Selected
		Delete Selected
		Delete All
	Printing	Print Recent
		Print Selected
		Print All
	System	Display Mode
		Display Direction
		Auto Power Off
		Backlight
		Key Tone
		Date/Time
		Password
		Key Setting
		RS-232 Baud Rate
		Default Setting
		Language
		Calibration
Information		

From the home screen, touch “MENU” to enter the main menu. (Figure 4-1)

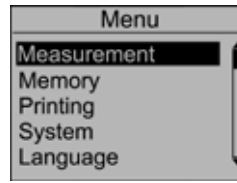

Figure 4-1a

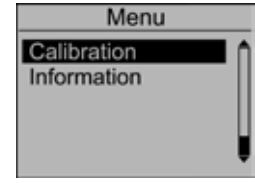

Figure 4-1b

#### 4.2 Measurement

The Measurement menu contains six selectable items: Unit, Group, Tolerance, Peak Time and Alarm. (Figure 4-2)

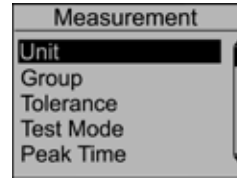

Figure 4-2a

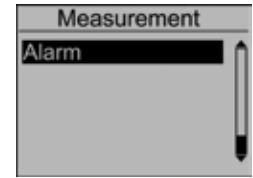

Figure 4-2b

##### 4.2.1 Unit

The measuring unit can be selected under this menu. Different range models may have different unit selection capabilities. Touch “ZERO” or “MENU” keys to shift to the next selection. Press “LOG” to cancel or touch “MENU” to confirm and exit. (Figure 4-2c)

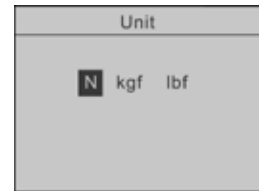

Figure 4-2c

##### 4.2.2 Group

When several test samples need to be measured, the samples can be coded into groups. The range is 01-99. When set to “00”, become, “01” automatically. Press “ZERO” to adjust the value, touch “MODE” to shift to the next position. Touch “LOG” to cancel; press “MENU” to confirm and exit. (Figure 4-2d)

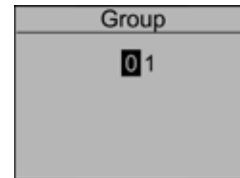

Figure 4-2d

##### 4.2.3 Tolerance

In the Tolerance menu, program high and low limit values to enable ok/ov testing. The lower limit value cannot be greater than the upper limit value, and neither limit value can be greater than 110% of the rated capacity. Press “ZERO” to adjust the value, touch “MODE” to shift to the next position. Press “LOG” to cancel; touch “MENU” to confirm and exit. (Figure 4-2e)

**NOTE:** Alarm must be set to on for tolerance values to be active.

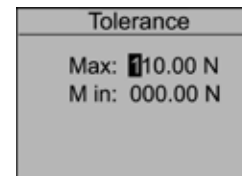

Figure 4-2e

#### 4.2.4 Test Mode

Change the mode of operation between the four modes. Press “ZERO” or “MODE” keys to select. Press “LOG” to cancel or “MENU” to confirm and exit. This adjustment can also be changed at the home screen display by simply pressing “MODE” (Figure 4-2f). First Peak Mode will display a drop ratio menu (Figure 4-2g). This drop ratio activates the first peak recording.

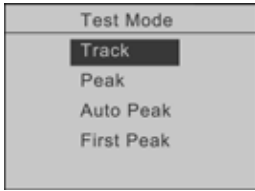

Figure 4-2f

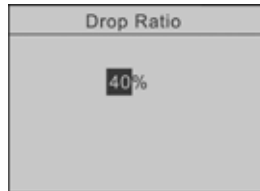

Figure 4-2g

#### 4.2.5 Peak Time

In the Peak Time menu, the peak auto reset time can be set. The range is 1-99 seconds. Touch “ZERO” to adjust the value, press “MODE” to shift to the next position. Press “LOG” to cancel; touch “MENU” to confirm and exit. (Figure 4-2h)

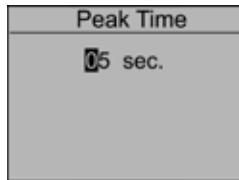

Figure 4-2h

#### 4.2.6 Alarm

The alarm function can be turned on or off to activate or deactivate the user programmed tolerances set in the Tolerance Menu. Touch “ZERO” or “MODE” keys to shift to the next position. Press “LOG” to cancel, touch “MENU” to confirm and exit. (Figure 4-2i)

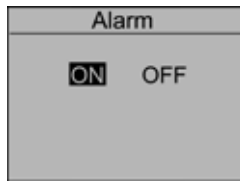

Figure 4-2i

### 4.3 Memory

In the Memory menu, the user can select the mode of data storage, browse, delete, or print the data. (Figure 4-3a)

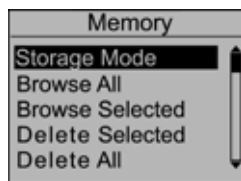

Figure 4-3a

#### 4.3.1 Storage Mode

Two storage modes can be selected in this menu: Single and Series. Touch “ZERO” or “MODE” keys to select between the two. Press “LOG” to cancel; touch “MENU” to confirm and exit. (Figure 4-3b)

*Single:* At the home screen, pressing the “LOG” stores the current displayed value. (If the default settings key is for storage. See 4.5.8 key setting.)

*Series:* Continuous data logging will only operate while in the Auto Peak measuring mode. When the peak time has expired, unit stores the current displayed peak value and then resets the peak value on the display. Touch “LOG” to start, touch “LOG” again to end.

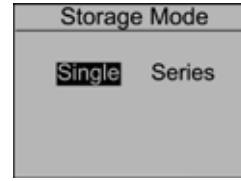

Figure 4-3b

#### 4.3.2 Browse All

The data will be displayed. Touch “ZERO” or “MODE” keys to shift to the next position. Touch “MENU” to see Delete or Print options. Touch “LOG” to go back. (Fig. 4-3c)

- ① Position number
- ② Data and units
- ③ Force Direction
- ④ First Position Data

No.	Force	Dir
007	12.0N	↕
008	23.6N	↕
009	34.8kgf	↕
010	123.5N	↕

Figure 4-3c

#### 4.3.4 Browse Selected

User can choose the data to browse. The available range of data stored is shown. Touch “ZERO” to adjust the value. Press “MODE” to shift to the next position. Press “LOG” to cancel; touch “MENU” to confirm. (Figure 4-3d)

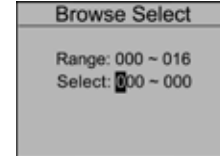

Figure 4-3d

#### 4.3.5 Delete Selected

Select the range of data to be deleted. Touch “ZERO” to adjust the value. Press “MODE” to shift to the next position. Touch “LOG” to cancel; touch “MENU” to confirm. (Figure 4-3e)

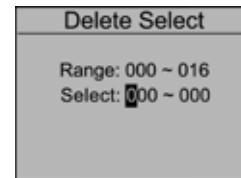

Figure 4-3e

#### 4.3.6 Delete All

In this menu, a prompt will appear. All data will be deleted by selecting “YES” and canceled by selecting “NO” or pressing “LOG”. (Figure 4-3f)

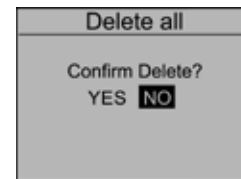

Figure 4-3f

## 4.4 Printing

The Printing menu contains three selectable items: Print Recent, Print Selected and Print All. (Figure 4-4a) The data saved in memory can be output to a printer through the serial port RS232 connection. (See 6.2.1 RS232 for more information) An example test report is shown in Figure 4-4b.

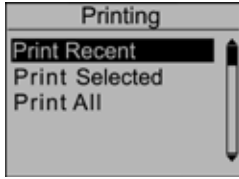

Figure 4-4a

Test Report		
001	12.0N	pull
002	23.6N	push
003	34.8kgf	push
004	123.5N	pull
005	305.0N	pull

Print Date: 2013-2-11

Figure 4-4b

### 4.4.1 Print Recent

Print recently stored data in this menu. The range is 0~19. (Figure 4-4c) Touch “ZERO” to adjust the value. Touch “MODE” to shift to the next position. Press “LOG” to cancel. Press “MENU” to confirm.

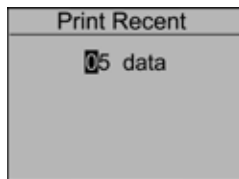

Figure 4-4c

### 4.4.2 Print Selected

In this menu, select the data range to print. Touch “ZERO” to adjust the value, touch “MODE” to shift to the next position. Press “LOG” to cancel; touch “MENU” to confirm. (Figure 4-4d)

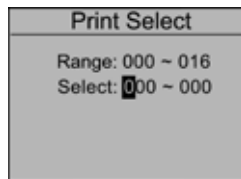

Figure 4-4d

### 4.4.3 Print All

To print all data saved in memory, a prompt window will display. All data will be printed by selecting “YES”. This operation will be canceled by selecting “NO” or touching “LOG”. (Figure 4-4e)

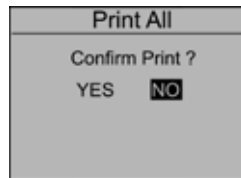

Figure 4-4e

## 4.5 System

Under the System menu, several parameters may be set per Figure 4-5a, 4-5b.

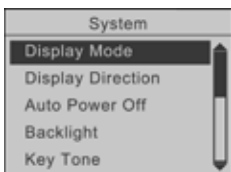

Figure 4-5a

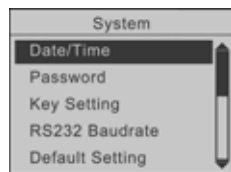

Figure 4-5b

### 4.5.1 Display Mode

Two display modes may be selected: Digital and Graphic (Figure 4-5c)

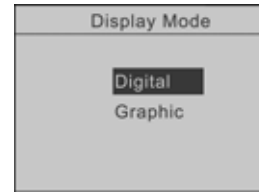

Figure 4-5c

### 4.5.2 Display Direction

Select the mode of the LCD display: Automatic, Obverse and Reverse. Touch “ZERO” or “MODE” keys to shift to the next position. Press “LOG” to cancel; Push “MENU” to confirm and exit. (Figure 4-5d)

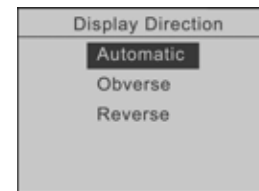

Figure 4-5d

### 4.5.3 Auto Power Off

To maximize battery life, the power can be set to shutdown after non-use. The time can be set in this menu. The range is 01-99 minutes. When set to “99” the gauge will never turn off. Touch “ZERO” to adjust the value, touch “MODE” to shift to the next position. Press “LOG” to cancel; Push “MENU” to confirm and exit. (Figure 4-5e)

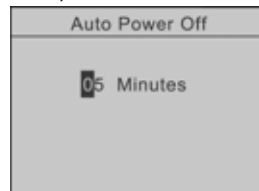

Figure 4-5e

### 4.5.4 Backlight

Under this menu, the backlight can be set to ON, OFF or have an auto shutdown. Touch “ZERO” or “MODE” keys to shift to the next position. Press “LOG” to cancel. Press “MENU” to confirm and exit. (Figure 4-5f)

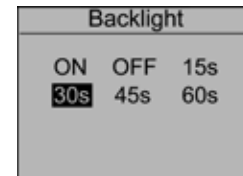

Figure 4-5f

### 4.5.5 Key Tone

Turn the key sound ON or OFF. Touch “ZERO” or “MODE” keys to shift to the next position. Touch “LOG” to cancel; Press “MENU” to confirm and exit. (Figure 4-5g)

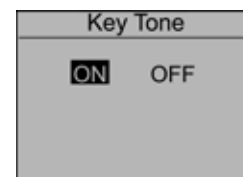

Figure 4-5g

#### 4.5.6 Date/Time

The system time may be set under this menu. Touch “ZERO” to adjust the value. Press “MODE” to shift to the next position. Touch “LOG” to cancel. Press “MENU” to confirm and exit. (Figure 4-5h)

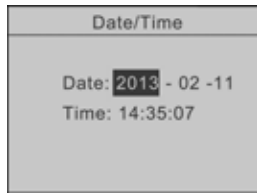

Figure 4-5h

#### 4.5.7 Password

The system password can be changed. First, enter the old password, then enter the new password and confirm the new password. The default System password is “123”. Touch “ZERO” to adjust the value. Press “MODE” to shift to the next position. Touch “LOG” to cancel; Push “MENU” to confirm and exit. (Figure 4-5i)

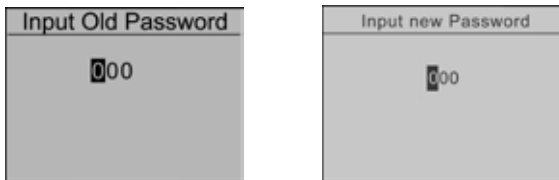

Figure 4-5i

#### 4.5.8 Key Setting

Set the default function of the “LOG” key from the home screen. The function can be set to print or store the current displayed value. Press “ZERO” or “MODE” to select the proper setting. Press “LOG” to cancel; touch “MENU” to confirm and exit. (Figure 4-5j)

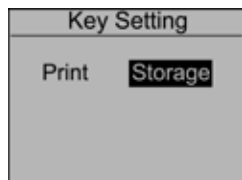

Figure 4-5j

#### 4.5.9 RS232 Baurate

Adjust Baurate to available bits per second selection in Figure 4-5k.

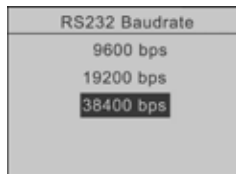

Figure 4-5k

#### 4.5.10 Default Setting

If you make a selection that you feel has caused the gauge to operate improperly, you can restore it to the factory default settings. Carefully use this function! (Figure 4-5l)

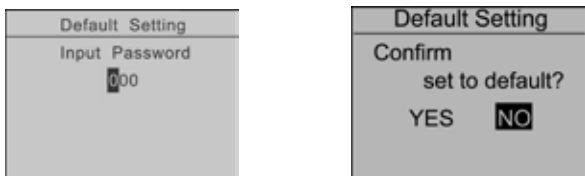

Figure 4-5l

#### 4.6 Language

Select between English, German and Chinese (Figure 4-6a)

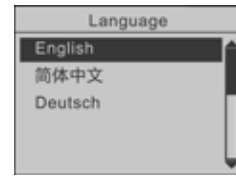

Figure 4-6a

#### 4.7 Calibration

Users can field-calibrate the gauge. First, enter the system password (Default is 123) by pressing the “ZERO” and “MODE” keys. Then press “MENU” to confirm. (Figure 4-7a)

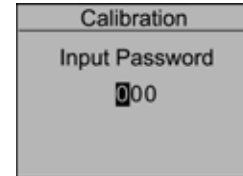

Figure 4-7a

- ① Calibration Point
- ② Current Value
- ③ Standard Input Value

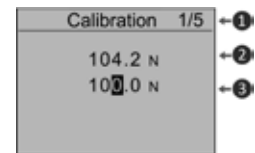

Figure 4-7b

Load a standard force on the gauge. Wait a moment for the force to stabilize. The current value (2) should equal the standard force applied.

If the values do not match, press “ZERO” and “MODE” keys to correct the standard input value (3).

Press “MENU” to enter the next calibration point. After any of the calibration points have been completed, touch “LOG” to exit the calibration mode. Then save the calibration or discard by pressing “Yes” or “No”.

After completing the calibration of the 5th point, the confirmation window will automatically ask to “Save and Exit” by selecting “Yes” or “No”. (Figure 4-7c)

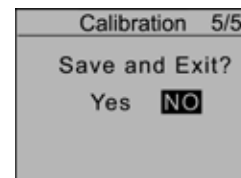

Figure 4-7c

Press “ZERO” or “MODE” to select, then press “MENU”. If “Yes” is selected, “Calibration Complete!” is displayed.

**NOTE:**

1. Ensure that the tare of attachment has been cleared before calibration.
2. For higher measuring precision throughout the test range, calibrating a point with a force at full scale is recommended.
3. Compression and tension calibrations are saved separately. The force gauge can identify the direction of the force, but each must be completed in a separate procedure.

**4.8 Information**

Information includes the model, version of the software and the serial number. (Figure 4-8a)

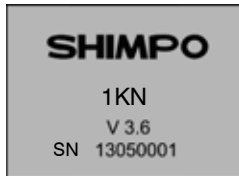

**Figure 4-8a**

**5. CHARGING**

The FG-7000L Series Digital Force Gauge is supplied with a set of 3 Nickel Metal Hydride AAA rechargeable batteries, which are supplied fully charged to allow immediate use. Users need to recharge batteries when a low battery icon flashes. Users should connect the gauge and the charger using the USB cable. Then connect the charger to an AC socket to start charging. Laptops and other USB devices can also charge the gauge. A fully charged battery pack will provide approximately 16 hours of constant use. Rechargeable battery pack:

- Type: Ni-MH 3.6VDC 800mAH rechargeable batteries
- Charging time: approx. 3~4 hours
- Battery life: approx. charge and discharge 500 times

**6. COMMUNICATIONS**

**6.1 USB**

The FG-7000L Series Digital Force Gauge is designed in accordance with USB2.0 standard protocol. (Figure 6-1a) The USB Port can be connected to a charger with the USB cable for charging the internal Ni-MH battery and can be connected to a computer for uploading the measured values. Connect the gauge and the computer with the USB cable, then open the computer software. Upload the values. Please refer to the software manual for additional information.

**6.2 Port Pin Assignments**

PIN#	Definition
1	RS232-Transmit
2	RS232-Receive
3	RS232-Ground
4	Comparison Output B
5	Reserved
6	Comparison Output C
7	Comparison Output A
8	Reserved

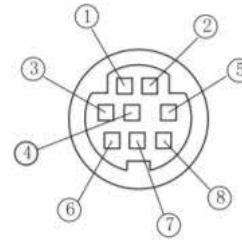

**Figure 6-1a**

**6.2.1 RS232**

The RS232 serial port is used to connect a printer to print the memory data.

RS-232 specifications are as follows:

- Data transmission: serial interface
- Synchronization: asynchronous
- Signal Level: RS-232 level, logic 1:-5v, logic 0: +5v
- Hardware Flow Control: None
- Data word length: 8 bits
- Stop bit: 1bit
- Parity: None
- Baud rate: 38400

**6.2.2 Comparison Output**

Comparison Output internal circuit shown as Figure 6-2a.

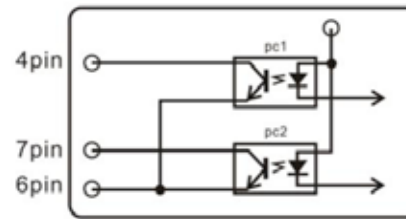
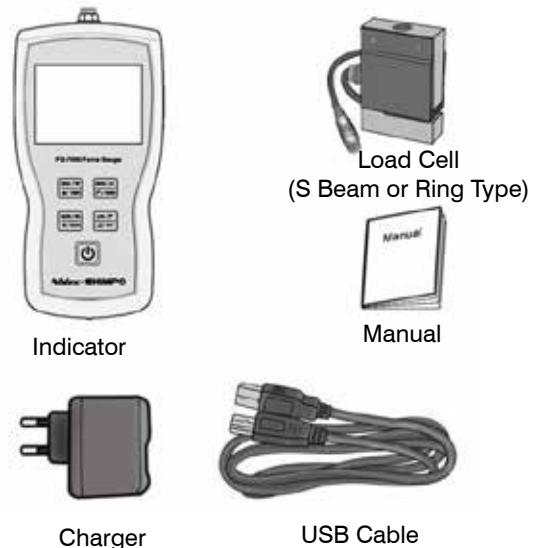

**Figure 6-2a**

When the measured value is less than the lower limit tolerance value, the “pc2” operates, 7pin and 6pin line conduction. When the measured value is more than the upper limit tolerance value or 110% of the rated capacity, the “pc1” operates, 4pin and 6pin line conduction. Maximum permissible voltage: 7pin to 6pin, 4pin to 6pin 35V; 6pin to 7pin, 6pin to 4pin 6V.

**7. MISC.**

**7.1 Parts List**



## 7.2 Diagram

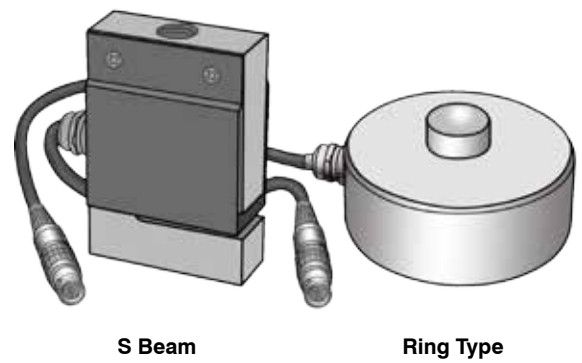
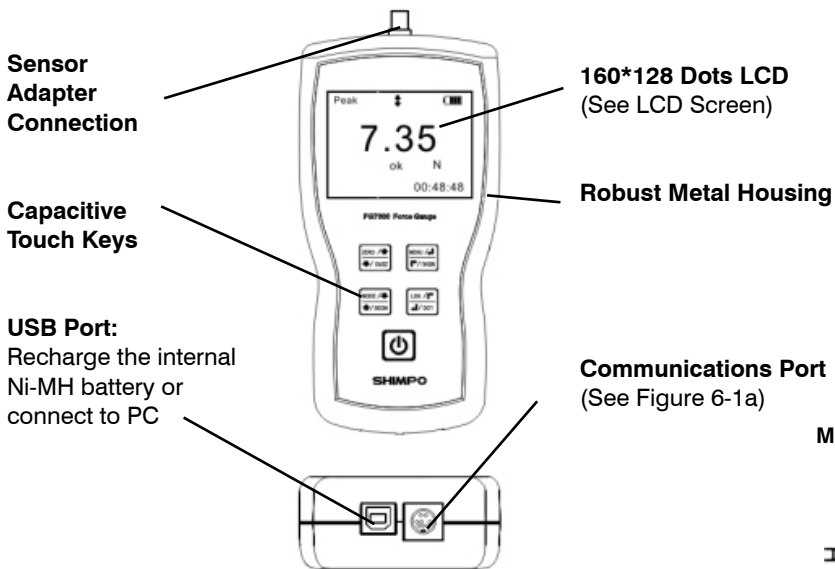

## 7.3 Dimensions

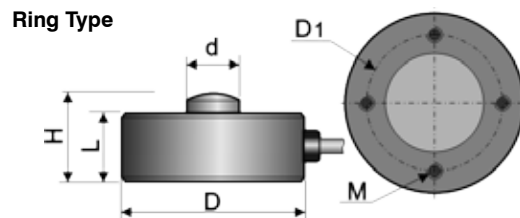
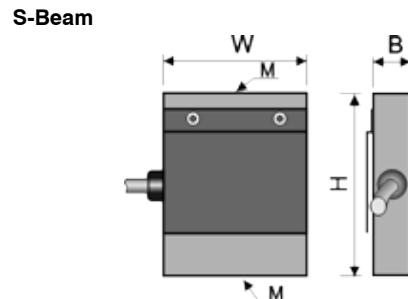
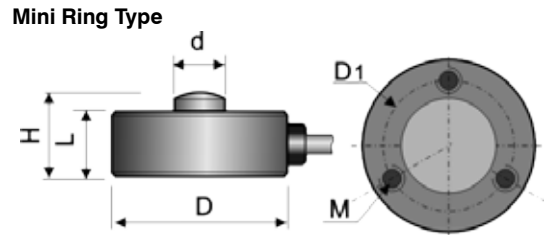
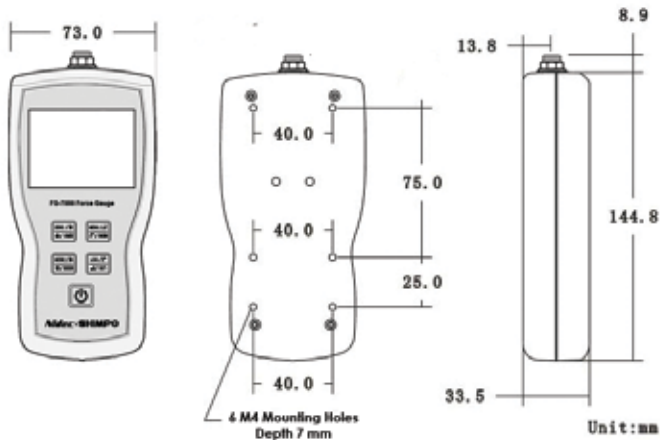

### S-Beam Load Cell

Capacity	Dimensions			
	W	H	B	M
1 kN	51	76	19	M12
2 kN				
5 kN				
10 kN				
20 kN			25.4	
20 kN	76.2	108		M18

### Ring Load Cell

Capacity	Dimensions (mm)					
	D	d	L	H	D1	M
10 kN	82	22	32	44	68	4-M8
20 kN						
50 kN						
100 kN						
200 kN	126	35	40	54	101	4-M10

### Mini Ring Load Cell

Capacity	Dimensions (mm)					
	D	d	L	H	D1	M
1, 5, 10 kN	32	8	14	16	24.5	3-M5
50 kN	38	11	14	16	30	3-M6
100 kN	51	15	22	25	41	4-M10

**NIDEC-SHIMPO CORPORATION**

**INSTRUMENTS DIVISION** • Phone: (800) 237-7079 • Fax: (630) 924-0342 • [www.shimpoint.com](http://www.shimpoint.com)