

Operation Manual



Warning

1) Overloading the transducer does not only damage the transducer but may break the transducer head and could result in injury!

2) Torque ranges of 25 N-m and higher must be fastened properly with 4 bolts and nuts to a secure work surface, either horizontally or vertically. Failing to do so may result in damage to the transducer and could result in injury to the operator. Ranges 10 N-m and lower do not require mounting and may be used with the included rubber feet as long as precaution is taken and unit is secured to prevent slippage.

3) Ensure that the torque wrench's driver has engaged the transducer socket properly when operating. The transducer head may be damaged if not engaged properly and could result in injury to the operator.

4) Please make sure that you have safety gear and safety precautions in place when applying torque to the transducer or when calibrating the transducer.

5) Do not use a charger other than the unit supplied with the TT torque tester. Using the incorrect charger may result in damage to the Ni-MH rechargeable batteries.



The TT Digital Torque Tool Tester is a simple operation test instrument for quickly checking torque tool performance. The TT Series provides exceptional accuracy for measuring torque on various products including torque wrenches, manual screwdrivers, electric screwdrivers, pneumatic screwdrivers and other torque controlled power tools.

The TT's provide long operation life and power flexibility with the ability to work from the internal rechargeable battery or included AC adapter. The TT's have four modes of operation: Track for live readings, Peak which records the highest level over a test, First Peak which records the first peak reading over the test and Track/Peak which shows both the live readings as well as the peak reading recorded.

The backlit display provides an analog bar graph on screen to allow the user to know where the resultant torque is currently positioned compared to the full scale range of the unit. CW/CCW icons along with programmable pass/fail LED's (HI/OK/LO) assist users with ensuring proper test set up along with enabling a quick determination of the results.

Every tester comes standard with USB and RS-232 output. The TT's software enables the uploading of data and the additional statistical analysis with its auto-calculation of the selected values.

These excellent features make the TT Torque Tool Testers a valuable and versatile addition to the production and quality control departments.

SPECIFICATIONS

Accuracy: $\pm 0.5\%$ of full-scale. (Includes Creep, Non-linearity & Temperature Shift at zero load)

Units of Measure: N-mm, N-cm, N-m, in-lb, ft-lb, kg-cm, kg-m (depending on range)

Measure Modes: Track, Peak, First-Peak, Track/Peak

Tool Socket Size: TT-0.5 to TT-50: Dual 3/8", 20 mm female square; TT-100 : 3/8"; TT-200 & TT-300: 1/2"

Overload Protection: 120% of Full Scale

Max. Mounting Torque: 150% of Full Scale

Sampling Rate: 1000 Hz

Peak Capture Rate: 0.10 S

Display: 175 x 1.125" (44.4 x 28.6 mm) dot matrix backlit LCD

Operating Temperature: 60 - 95 °F (15 to 35 °C)

Storage Temperature: 5 - 149 °F (-15 to 65 °C)

Humidity Limit: Maximum 70% rH.

Power Requirement: 500 mA 9 VDC

Charging Time: Approx. 14-16 Hours for Full Charge

Battery Operation: 12 Hours

Output: USB 8 data bits Baud rate: 38400

Communication Ports: Both RS232 & USB simultaneous output

Size: TT-0.5 to TT-10: 4 x 8 x 2" (100 x 200 x 50 mm);

TT-25 to TT-300: 4 x 9.8 x 2.3" (100 x 250 x 58 mm)

Product Weight: TT-0.5 to TT-10: 4.70 lb (2.13 kg);

TT-25 to TT-300: 7.65 lb (3.47 kg)

Package Weight: TT-0.5 to TT-10: 9.10 lb (4.13 kg);

TT-25 to TT-300: 12.15 lb (5.51 kg)

Warranty: 1 year

Included Accessories: USB cable, charger adapter, cal. cert., rundown adapter (TT-0.5 to TT-50 only), 1/4" male Hex to 3/8" square driver adapter. (TT-0.5 to TT-50 only)

Optional Accessories: RS-232 cable, Rundown adapter springs, Rundown adapters. Note: Software available for free download at www.shimpoint.com.

INTRODUCTION

Thank you for selecting the Nided-Shimpo TT series torque tool tester. With correct use and regular re-calibration, the TT tool tester will provide many years of accurate and reliable service.

The Series TT can accurately measure torque in both the Clock-Wise (CW) and Counter Clock-Wise (CCW) direction. The TT provides simple user operation and is accompanied with software and accessories to simplify your torque testing needs.

Before Use

Upon receiving the unit, please check that no physical damage has occurred to the packaging, plastic carrying case or the instrument itself. If any damage is evident, please notify Nidec-Shimpo immediately.

Operation Overview

The most commonly used features, such as displaying torque, peak hold, zeroing and changing of displayed units, can all be done by pressing a single dedicated key identified on the front panel. See the Basic Functions section. To access the menus, simply press the Menu key to access the tester configurations. See the Main Menu section.



Figure 1: TT Keypad

ZERO: Resets the displayed value to zero

POWER: Turns unit on/off

UNIT: Home screen changes engineering units. In Menus, moves cursor to the right position

MODE: Home screen, scrolls through 4 modes of operation. In menus, moves cursor down in the list or decreases a value

RESET: Home screen, resets the maximum values. In menus, moves cursor up in the menu list or increases a value

ENTER/MEM: Home screen, enters data into memory storage In menus, enters into sub-menus, makes selections and enters values.

MENU/ESC: Home screen, enters into menus In menus and sub-menus, returns one level

PRINT: Home screen, sends current reading to PC In Menus, moves cursor to the left position

POWERING THE FIRST TIME

The TT is supplied with a set of Nickel Metal Hydride 4xAAA rechargeable batteries. For safety reasons during transportation the batteries are shipped discharged. To obtain maximum battery life we recommend that you charge them with the supplied charger/adaptor for at least 14-16 hours when you first receive the instrument.

Battery Indicator

If battery level shows empty, a "battery empty" message will be displayed and the tester will power down automatically.

Important: Only use the adaptor/charger supplied.

USING THE TT

Fitting Accessories

If power torque tools are used, the rundown adapter provided can be inserted to the torque transducer head. For wrench and torque screwdrivers, you may need a matching adapter.

Power Up

To power up the tester press the ON/OFF key. A short self-test runs during which the display will show the capacity in Newtons.

The TT re-zeroes itself during the self-test routine.

After the self-test, providing no load has been applied to the instrument, the display will show all zeroes.

***Do not overload** the load sensor. This will cause irreparable damage. Torques greater than 120% of full-scale will produce an audible beep and OL symbol will blink on the display until the load is released and the RESET key is pressed.

To power down the tester press the ON/OFF key.

***All the current settings are saved** when the tester is turned off. The tester will function in the same mode when powered up again.

Basic Functions

Clock-Wise(CW) torque is displayed by the right pointing arrow symbol (see image below). Counter Clock-Wise torque is displayed by the left pointing arrow symbol (see image below).

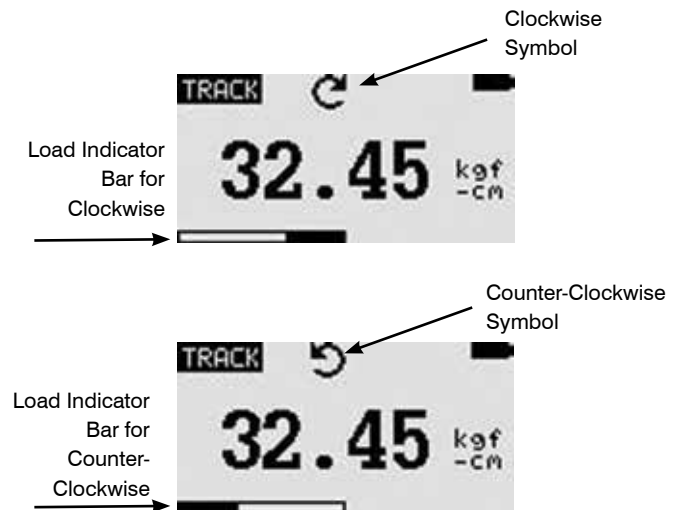

Figure 2: Display of Clockwise & Counter-Clockwise

A load indicator bar alerts the operator how much load has been applied to the load sensor in relation to the full scale of the sensor. For clockwise torque the indicator bar moves from right to left. For counter-clockwise torque the indicator bar moves from left to right.

Zeroing the Tester

During operation of the TT, it is often necessary to zero the display so that minor errors do not become part of the measured reading. Press and release the ZERO key.

Changing the Engineering Units

Depending on the capacity of your model, the following units may be selected by pressing the UNITS key: N-mm, N-cm, N-m, gmf-cm, kgf-cm, kg-m, ft-lbf, in-lbf. The TT automatically converts readings as the new engineering unit is selected.

Changing the Mode

Press the Mode key to choose from the following modes of measure: Track, Peak, First Peak and Track/Peak

Track Mode

When “Track” appears in the display the TT will indicate live torque readings in both directions as they are applied. See Figure 3a



Figure 3a: Track

First Peak Mode

When “F-Peak” is selected the TT will show the initial maximum torque recorded over the test. Once the unit sees a drop in torque, the First Peak will be displayed. A subsequent increase after the drop will not be recorded. See Figure 3b

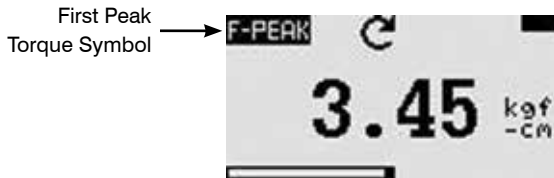

Figure 3b: F-Peak Torque

Peak Mode

When “Peak” is selected the TT will show the maximum torque recorded over the test. Subsequent increases in the peak will replace the existing peak value shown. See Figure 3c

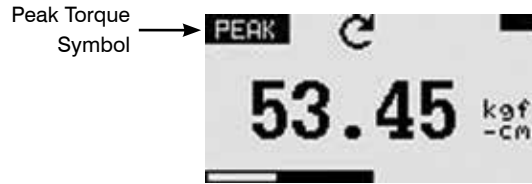

Figure 3c: Peak

Peak/Track Mode

There are two readings on the screen at once. Upper area displays the peak torque. The larger, main value shows the live torque reading.

- Press “Mem” button: Only peak torque will be stored in the tester’s memory.
- Press “Print” only: The peak torque will be sent to PC

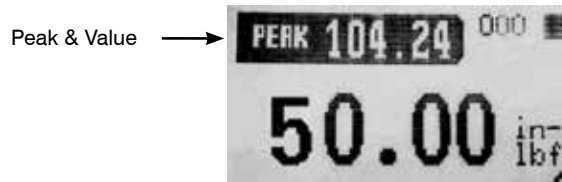

Figure 3d: Peak Torque

Resetting the Tester

Press the RESET key to clear maximum readings.

Backlit Display

When you press any key, or apply torque to the load sensor greater than 0.5 % of full scale the backlight will come on and remain for 60 seconds.

Saving Readings to Memory

A reading can be saved at any time by pressing ENTER/MEM key. A total of 500 readings may be stored in the database.

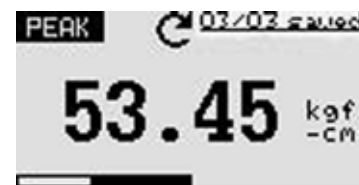

Figure 3e: Number of values saved in Memory

Computer Communication

A computer can communicate with the TT through either the RS-232 or USB connections. See commands and actions below.

Command	Action
"m"	Change the measure mode.
"u"	Change the engineering unit.
"z"	Zero the tester.
"r"	Reset the tester.

Output Signal

The displayed reading may be transmitted to a PC by pressing the PRINT key or sending a request command from the PC to the TT via USB or RS-232 ports.

Command	Action
"l"	Send live reading value with unit.
"p"	Send peak Torque value with unit.
"c"	Send peak Torque value with unit.
"x" or pressing PRINT key	Send live reading value with unit, if current mode is track mode. Send peak Torque value with unit, if current mode is peak Torque mode. Send peak Torque value with unit, if current mode is peak Torque mode.
"d"	Send memory
"i"	Send information of tester (model, capacity, serial number, firmware revision, original offset, current offset, overload count).

MAIN MENU

Press MENU/ESC key to access the main menu. To move between the sub-menus listed, press the UP and DOWN arrow keys to move the cursor. Press ENTER to select the sub-menus, activate features and enter values. Within the sub-menus the UP, DOWN, LEFT and RIGHT arrow keys will also change numerical values. Press ESC to return to the main menu page.

MAIN MENU
1) SETUP
2) MEMORY
3) CALIBRATION
4) DIAGNOSTIC
5) ABOUT

Figure 4: Main Menu

1) SETUP

- 1) AUTO-OFF
- 2) PASS-FAIL

a) **AUTO-OFF**: With AUTO-OFF highlighted, press the ENTER key. The display will show the Auto-OFF options. See Figure 5. Press the ESC key to return to the main menu page.

The Auto-OFF feature can be enabled to conserve battery life where the TT powers down after inactivity of 5, 10 or 15 minutes. Press ENTER to select the desired option and return to the main menu page. The power symbol "⓪" will appear on the home screen when this feature is active.

AUTO-OFF MENU
1) OFF
2) 5 MINUTE
3) 10 MINUTE
4) 15 MINUTE

Figure 5: Auto-Off Menu

b) PASS-FAIL

With PASS-FAIL highlighted, press ENTER. The Pass-Fail feature is used to set an acceptable maximum and minimum torque zone for testing. It activates by setting the lower level and upper level torque limits. If the torque value is within the thresholds, the display will show PASS. Any values outside this zone (higher or lower), will display FAIL. If you activate this feature, a PF symbol will display at the home screen.

Alter Units at bottom

PASS FAIL MENU
UPPER= <u>2.5</u>
LOWER= 1.0
Unit=in-lbf
ZERO key to reset

Figure 6: Pass-Fail Menu

Use the LEFT ARROW key to move between the values. Use the UP and DOWN keys to change the values. Press and hold to adjust the values more quickly. Use the RIGHT ARROW key to change the units. Press ENTER to save the settings and return to main menu page.

**Either UPPER or LOWER Levels can be disabled if you set to 0.*

**If UPPER is active, LOWER value must be less than the UPPER.*

Example: LOWER LEVEL = 0 N.m, UPPER LEVEL = 20 N.m

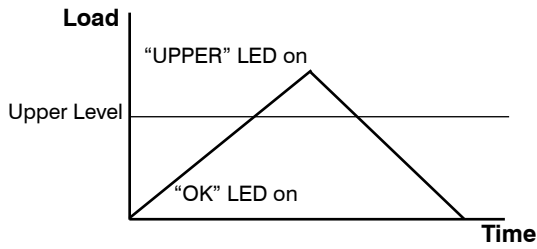

Figure 6a

Example: LOWER LEVEL = 20 N.m, UPPER LEVEL = 0 N.m

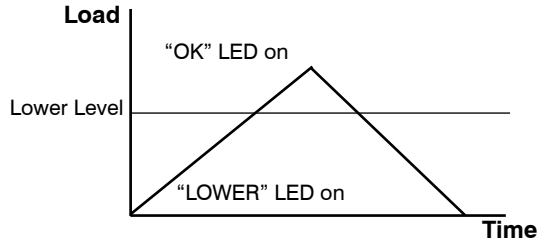

Figure 6b

Example: LOWER LEVEL = 10 N.m, UPPER LEVEL = 20 N.m

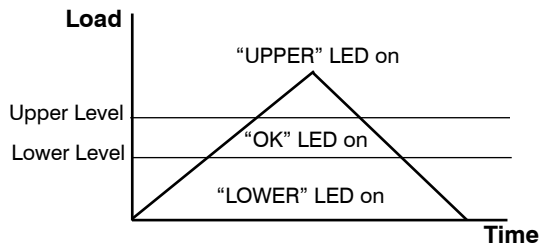

Figure 6c

2) MEMORY: The TT offers the ability to view saved records, delete last or delete all records. It can also upload the data if connected to a PC. To access, in the menu list highlight Memory and press ENTER.

MEMORY MENU
1) VIEW
2) DELETE LAST
3) DELETE ALL
4) UPLOAD ALL

Figure 7: Memory Menu

In the VIEW sub-menu, Press UP and DOWN to scroll through the list of values. Press and hold to scroll through more quickly.

Select 2) Delete Last and press ENTER. Choose Yes and the tester will delete the last saved record and return to the Memory menu. If you selected 3) Delete All and press ENTER, choose Yes to remove all stored records. The unit will automatically return to the memory menu after the selection.

To upload all the values to the PC software program, highlight UPLOAD ALL and press the ENTER key.

3) CALIBRATION: The calibration feature is used by service technicians for calibrating the tester. Proper equipment is required to perform this task. Contact Nidec-Shimpo or your dealer for additional details.

4) DIAGNOSTIC: This diagnostic feature is used to check status of the load cell. If you suspect that your load cell transducer has sustained an overload, it is possible to check the status. Place the tester horizontally on the flat level surface and select "DIAGNOSTIC" in the main menu.

DIAGNOSTIC	
OVERLOAD COUNT: 2	← A total of overload count
ORG. OFFSET: +0.4%	← % offset from the prior calibration
CUR. OFFSET: +0.4%	← Current % offset

Figure 8: Diagnostic Menu

If the % offset is between 5% - 10 % please contact Nidec-Shimpo or your supplier to arrange for a proper calibration.

If the % offset is greater than 10% the unit is possibly damaged and needs repair or replacement.

These values are given as an indication only. The need for calibration or repair may vary according to the individual characteristics of the load cell.

5) ABOUT: The ABOUT sub-menu displays the information of your unit such as Firmware revision, Model, Capacity and Serial number.

ABOUT
FIRMWARE REV.: 1.00
MODEL: TT
CAPACITY: 10 N.M
S/N: 05130001

Figure 9: About Menu

MOUNTING: For proper operation and safety, it is necessary to mount the torque tester with ranges of 25 N-m and higher. Fasten the integral mounting bracket properly with 4 bolts and nuts to a secure work surface. Mounting may be vertical or horizontal. For lower torque ranges, this mounting bracket adapter is available as an accessory if securing to a work surface is desired. To install the bracket to the back of the unit, remove the four outer screws with rubber feet. Discard the rubber feet. Line up the adapter plate's four holes with the four outer threaded inserts on the bottom of the TT. Attach the adapter bracket with the four screws that were previously removed. Tighten securely. Line up the adapter plate's four holes with the four outer threaded inserts on the bottom of the TT.

CAPACITY & RESOLUTION

Range by Unit (Resolution)							
Model	N-mm	N-cm	N-m	kgf-cm	kgf-m	in-lbf	ft-lbf
TT-0.5	500 (0.1)	50 (0.01)	0.5 (0.0001)	5.099 (0.001)	0.0509 (0.0001)	4.425 (0.001)	0.3688 (0.0001)
TT-1	1000 (0.2)	100 (0.02)	1 (0.0002)	10.2 (0.002)	0.1019 (0.0001)	8.852 (0.002)	0.7374 (0.0002)
TT-5	5000 (1)	500 (0.1)	5 (0.001)	50.99 (0.01)	0.5098 (0.0001)	44.25 (0.01)	3.688 (0.001)
TT-10	10000 (2)	1000 (0.2)	10 (0.002)	102 (0.02)	1.0196 (0.0002)	88.52 (0.02)	7.374 (0.002)
TT-25	25000 (5)	2500 (0.5)	25 (0.005)	254.9 (0.05)	2.549 (0.0005)	221.3 (0.05)	18.435 (0.005)
TT-50	-	5000 (1)	50 (0.01)	509.8 (0.1)	5.098 (0.001)	442.5 (0.1)	36.88 (0.01)
TT-100	-	10000 (2)	100 (0.02)	1019.7 (0.2)	10.196 (0.002)	885.2 (0.2)	73.74 (0.02)
TT-200	-	20000 (5)	200 (0.05)	2039.4 (0.5)	20.39 (0.005)	1770 (0.5)	147.5 (0.05)
TT-300	-	30000 (5)	300 (0.05)	3059 (0.5)	30.59 (0.005)	2655.5 (0.5)	221.25 (0.05)

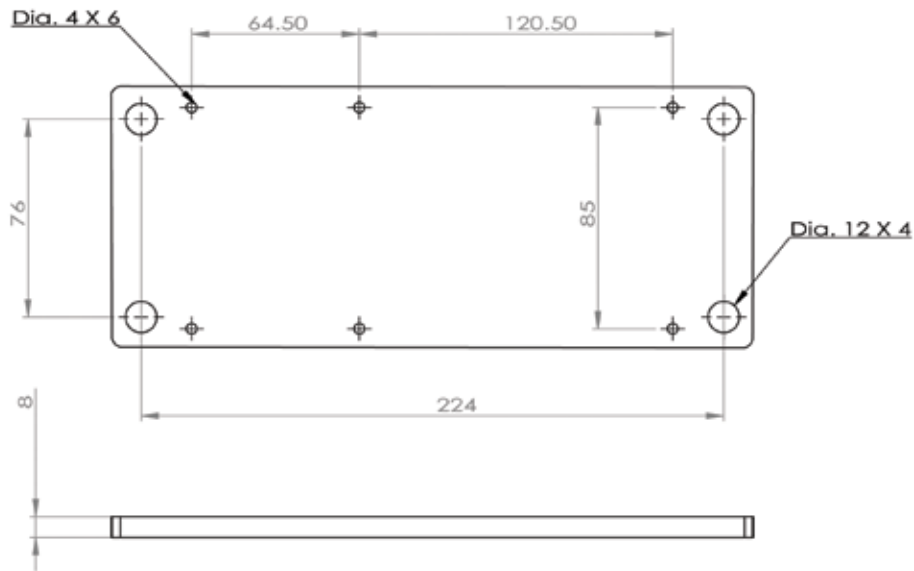

Unit: mm
Material: Painted steel

TT-BP: Optional Mounting Bracket
(Comes Standard with TT-25 to TT-300 Models)