

Manual Lever Test Stand Model FGS-5S (Vertical or Horizontal)

Instruction Manual



Mounting Bracket

Shimpo Force Gauges

1. Remove the bracket from the test stand using the 5mm Allen wrench included.
2. Use the mounting holes marked "A" on the diagram for mounting the FGE and FGV series force gauges with the (4) M4x8 Philips head screws included.
3. Use the mounting holes marked "B" on the diagram for mounting the DFS series force gauges with the (3) M5x6 Philips head screws included.
4. Adjust the clearance span by removing the hex bolt from the hole in the back of the stand. Loosen but do not remove the hex bolts from the (3) slots. Adjust the span by sliding the drive unit to the hole position desired and insert the hex bolt and tighten. Tighten the (3) hex bolts in the slots as well.
5. Re-install the bracket with the force gauge to the test stand.
6. Testing may now begin with the force gauge and test stand.

Specifications

Capacity:	22Kg (50lbs.)
Travel:	50mm (1.97in.) MAX
Clearance:	40, 70, 100mm (1.6, 2.75, 3.94 in.)
Weight:	10Kg (22lbs.)

Accessories

Mounting bracket	1pc.
Cable holder	1pc.
5mm Allen wrench	1pc.
Philips head screw M4x8	4pcs.
Philips head screw M5x6	3pcs.

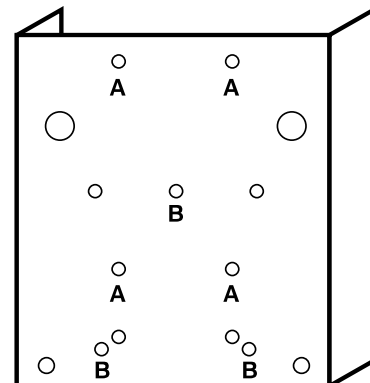

Mounting Bracket

Dimensions

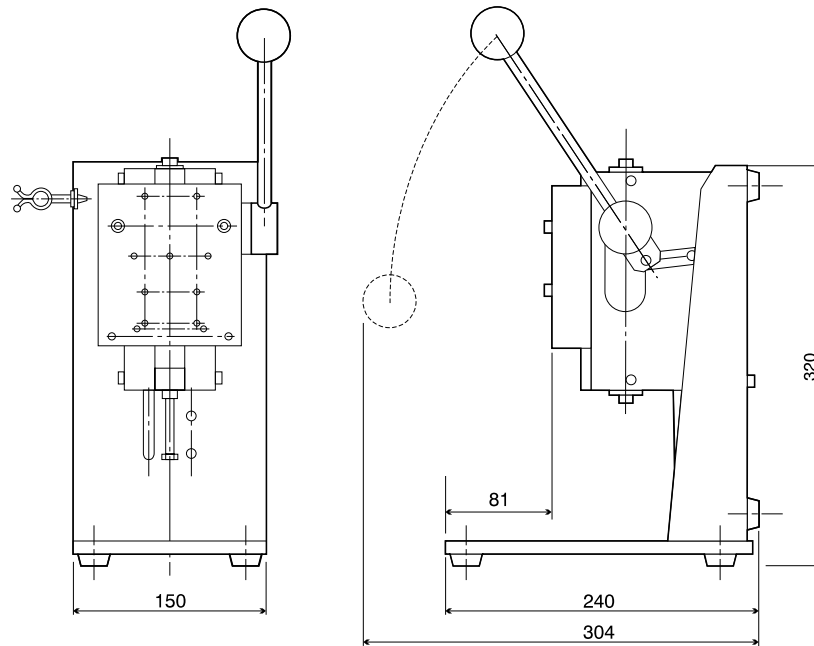

Dimensions in mm

SHIMPO ONE-YEAR WARRANTY

LIMITED EXPRESS WARRANTY: Shimpo Instruments warrants, to the original purchaser of new products only, that this product shall be free from defects in workmanship and materials under normal use and proper maintenance for one year from the date of original purchase. This warranty shall not be effective if the product has been subject to overload, misuse, negligence, or accident, or if the product has been repaired or altered outside of Shimpo Instruments's authorized control in any respect which in Shimpo Instruments's judgment, adversely affects its condition or operation.

DISCLAIMER OF ALL OTHER WARRANTIES: The foregoing warranty constitutes the SOLE AND EXCLUSIVE WARRANTY, and Shimpo Instruments hereby disclaims all other warranties, expressed, statutory or implied, applicable to the product, including, but not limited to all implied warranties of merchantability and fitness.

LIMITATION OF REMEDY: Under this warranty, Shimpo Instruments's SOLE OBLIGATION SHALL BE TO REPAIR OR REPLACE the defective product or part, at Shimpo Instruments's option. Shimpo Instruments reserves the right to satisfy warranty

obligation in full by reimbursing Buyer for all payments made to Shimpo Instruments, whereupon, title shall pass to Shimpo Instruments upon acceptance of return goods. To obtain warranty service, Purchaser must obtain Shimpo Instruments's authorization before returning the product, properly repackaged, freight pre-paid to Shimpo Instruments.

INDEMNIFICATION & LIMITATION OF DAMAGES: Buyer agrees to indemnify and hold Shimpo Instruments harmless from and against all claims and damages imposed upon or incurred arising, directly or indirectly, from Buyer's failure to perform or satisfy any of the terms described herein. In no event shall Shimpo Instruments be liable for injuries of any nature involving the product, including incidental or consequential damages to person or property, any economic loss or loss of use.

MERGER CLAUSE: Any statements made by the Seller's representative do not constitute warranties except to the extent that they also appear in writing. This writing constitutes the entire and final expression of the parties' agreement.