

SHIMPO

DT-326

LED Stroboscope

Operation Manual

Read manual thoroughly prior to operation.

Use instrument only after reading the complete manual.

Follow all safety precautions.



Safety Precautions

Please be sure to closely follow all safety precautions.

Be sure to read the entire instruction manual thoroughly before initial set-up, operation and maintenance. The instruction manual provides two grades of safety warnings: "Danger" and "Caution". Follow these precautions.



"Danger" marking indicates possible death, severe injury or fire if the user disregarded.





"Caution" marking indicates possibility of severe bodily injury or object damage if operated improperly.









This warning indicates a prohibited operation.



Execute this warning.

 Danger	
	Never use in flammable environments. May result in fire or explosive.
	Never look directly into the LED light source. May result in eye injury.

 Caution	
	Do not drop. May cause damage or injury.
	Avoid the following. Direct sunshine, condensation, dust or caustic Chemicals, combustible gases Oils, water, salts
	Do not alter, modify or dispose of improperly. May cause damage, accidents and void warranty.
	Operate within 0-35°C(32-95°F), 35-85%RH May alter operation of the unit.
	To clean, gently wipe with a soft cloth. No volatile chemicals such as usage Benzene, Thinner, or Alcohol.
	Hot! Use a tripod or other fixed device for over 2 hour of continuous operation.

- Contents -

1	Summary.....	1
2	Product Inspection and Preparation.....	2
2.1	Confirmation of product packaging.....	2
2.2	Removal of protective sheet.....	3
2.3	Installation of Battery.....	3
3	Names and functions of the components.....	4
3.1	DT-326 Unit.....	4
3.2	Operation panel.....	5
3.3	LCD Display.....	6
3.3.1	Display Names and Descriptions.....	6
3.3.2	Main data display.....	6
3.3.3	Sub data display.....	6
3.3.4	Units of Measure: Display.....	6
3.3.5	Setting project display.....	7
3.3.6	Battery Indication.....	7
4	Function Instructions.....	8
4.1	Power on/off.....	8
4.2	Mode Selection.....	8
4.3	Internal flashing mode.....	9
4.3.1	Instruction for Internal flashing mode.....	9
4.3.2	Changing Units of Measure in Internal Mode.....	9
4.3.3	ECO function.....	9
4.3.4	Flash rate and frequency “Internal Mode”.....	10
4.3.5	Multiply / Divide by 2 Function.....	11
4.3.6	Phase Shift (Angle).....	12
4.3.7	Flash Pulse Duration (RATIO) setting.....	12
4.4	External Trigger Mode.....	15
4.4.1	External trigger mode: LCD display information.....	15
4.4.2	Flash Delay Setting.....	15
4.4.2.1	“Delay time” setting.....	16
4.4.2.2	“Delay angle” setting.....	18
4.4.3	Units of Measure- Changing from FPM to Hz.....	19
4.4.4	ECO feature.....	19
4.5	Parameter Setting Instruction.....	20
4.5.1	Measurement range setting.....	21
4.5.2	Trigger Edge setting (External Mode).....	23
4.5.3	Delay setting.....	25
4.5.3.1	Delay time setting.....	25
4.5.3.2	Delay angle setting.....	26
4.5.4	Back light setting.....	27
4.6	Power-saving settings.....	27
4.6.1	LED flashing auto off.....	27
4.6.2	Auto Power off.....	27
4.6.3	LCD back light off.....	27
4.7	Connector of External input/output.....	28
4.7.1	Connector specs and pin type.....	28
4.7.2	External Pulse Input.....	28
4.7.3	External pulse output.....	28
4.7.4	Option Cable- Input/ Output cable adaptor.....	29
5	Specifications.....	30
6	Dimensions.....	32

1 Summary

The DT-326 LED Stroboscope is a portable, AC/DC powered precision instrument used to illuminate and measure the rotational speeds of objects with a certain speed and a constant period. By illuminating the rotating object with the DT-326, the moving object appears to remain still when the flashing rate of the DT-326 is equal to the rotational speed of the target object. This allows inspection of rotating and moving parts, gears, shafts and others. Additionally, the target object can appear to rotate back or forth (frequency) by utilizing the phase shift function.

Main features

Two units of measure- FPM (flashes per minute) and Hz.

=> **refer to 4.3.2 unit conversion**

Wide flash range- 60 to 120,000 FPM

=> **refer to 4.3.4 Flash rate setting**

Multiply or Divide by 2- function to quickly adjust flash rate

=> **refer to 4.3.5 Multiply/Divide the flash rate by 2**

Phase Shift function - "+3°", "-3°"

=> **refers to 4.3.6 Phase shift by degrees**

Adjustable flash duration – (RATIO) Time can change for 0.1° each time as in the range of 0.1°/360° - 2.5°/360°

=> **refer to 4.3.7 Flash duration (ratio) setting**

External input/output port-Synchronization of flash rate with external pulse, or flash rate pulse signal output

=> **refer to 4.4 External trigger model, 4.7 External input/output connector**

2 Product Inspection and Preparation

2.1 Confirmation of product packaging

Confirm the following five parts in your DT-326 packaging:

1. One (1) LED stroboscope



2. Four (4) alkaline batteries (AA)

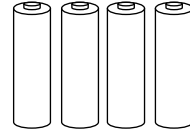

3. One (1) AC Adapter (120V/240V, 50/60Hz)

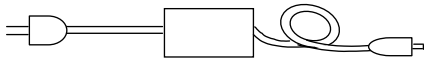

4. One (1) set of External input/output connector
3240-10P-C [HIROSE ELECTRIC CO., LTD.]

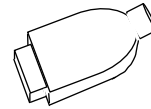

5. Operation Manual

6. One (1) Option Cable- Input/ Output cable adapter if you ordered



2.2 Removal of protective sheet

Remove both protective sheets covering the operation panel and light source as shown below.

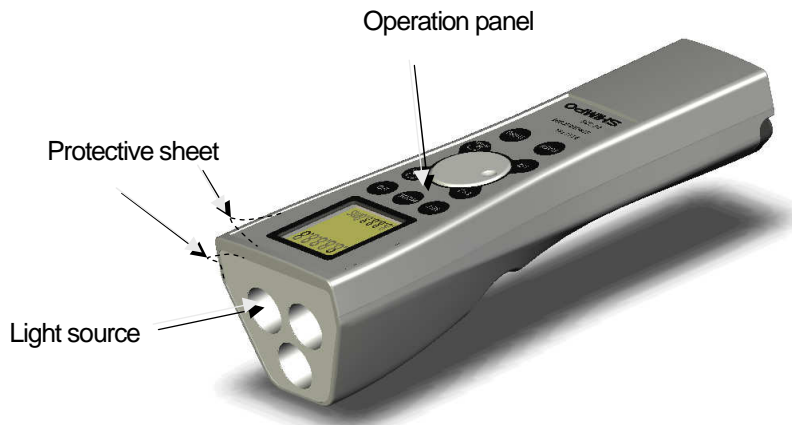

2.3 Installation of Battery

Turn coin screws counter-clockwise to remove battery cover, and insert batteries in proper polarities as shown below:

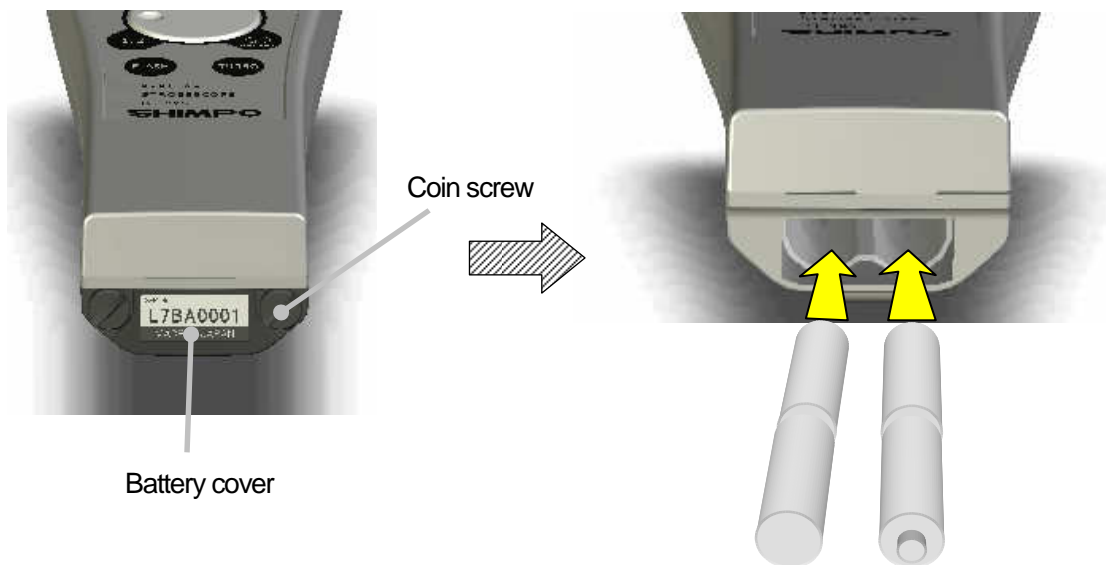

*** Avoid battery leakage/ corrosion when not in use for extended period of time.**

3 Names and functions of the components

3.1 DT-326 Unit

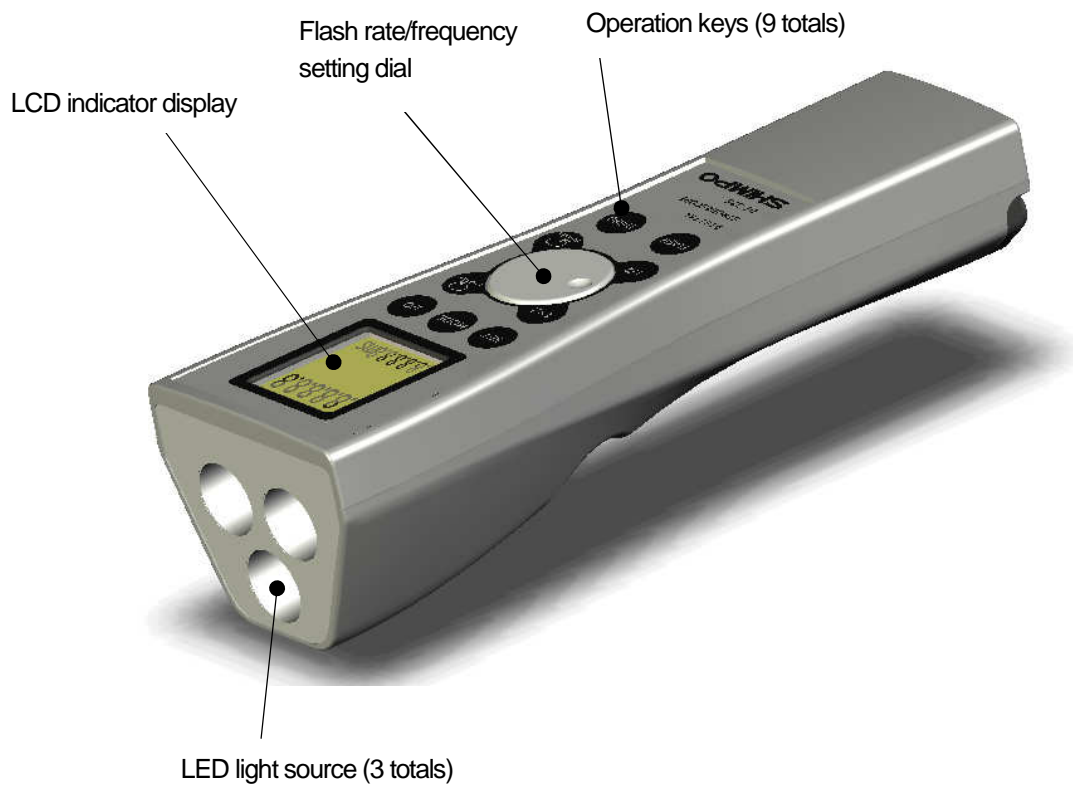

3.2 Operation panel

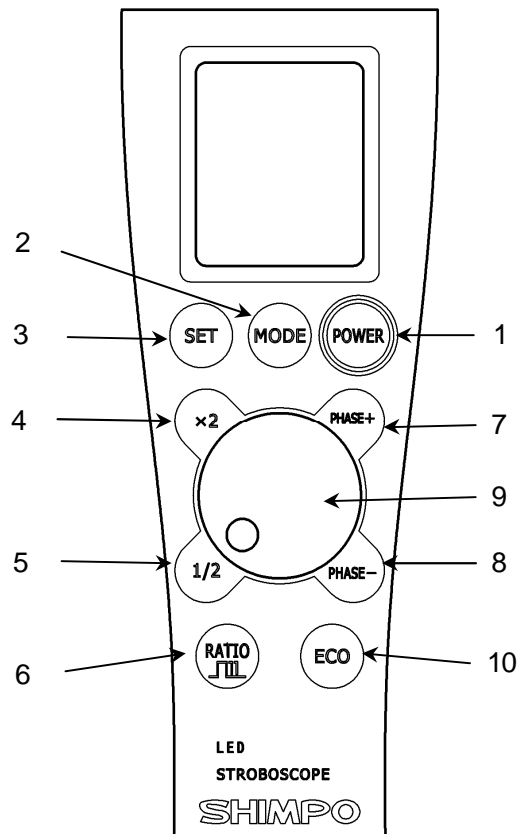

No.	Key	Function Instructions
1	POWER	Power the unit on or off
2	MODE	Select Internal/ External/ Parameter mode of operation instruction
3	SET	Unit change, Select parameter setting item, Store setting value.
4	x2	Multiplies the flash rate/frequency by a factor of 2.
5	1/2	Divides the flash rate/frequency by a factor of 2.
6	RATIO	Adjusts the flash duration (flash pulse width) in Internal/External mode.
7	PHASE “+”	Advance image forwards 3 degrees at a time in internal mode. In parameter setting mode, change setting value.
8	PHASE “-“	Retard image backwards 3 degree at a time in internal mode. In parameter setting mode, change setting value.
9	Dial	Set flash rate or frequency. CW; Increase flash rate/frequency. CCW; Decrease flash rate/frequency. (Turn dial “quickly” to drastically change value. Turn dial “slowly” to change value 1 digit.) In parameter setting mode, CW or CCW rotating changes the setting value.
10	ECO	Push once to reduce LED brightness (Economy mode). Push again to return back (Normal mode).

3.3 LCD Display

3.3.1 Display Names and Descriptions

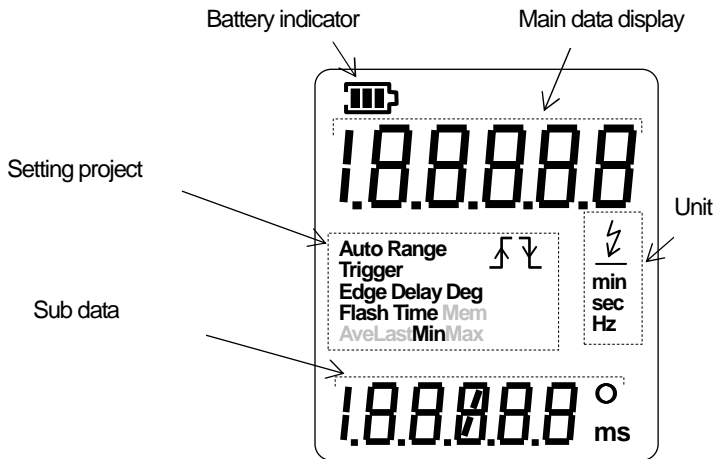

3.3.2 Main data display

- Internal flashing mode: Displays flash rate.
- External trigger mode: Display external trigger frequency.
- Display will indicate "P" or "LCD" (in ON/OFF setting of LCD backlight) in *Parameter setting mode.

*Parameter setting mode: Display LCD backlight setting ("P" or "LCD")

3.3.3 Sub data display

Internal Flash Mode Display

- To change the degrees of phase shift, press PHASE + or PHASE - keys. The display will reflect the cumulative angle of phase shift.
- "Flash Time" will be displayed when RATIO key is pressed. The flash time (pulse flash duration) can then be set using the dial to increase or decrease the flash time from 0 to 2.5 (0 - 2.5°) degrees.

External Trigger Mode Display

- Displays delay time setting. Refer to section 4.4.2 for detail.

*Parameter Mode Display

- Displays the following:
 - Selected measuring range
 - Delay time (in ms)
 - Backlit LCD (ON or OFF)

*Refer to 4.5 "Parameter setting mode" for detail.

3.3.4 Units of Measure: Display

Digital display will show the following according to the unit of measure setting.

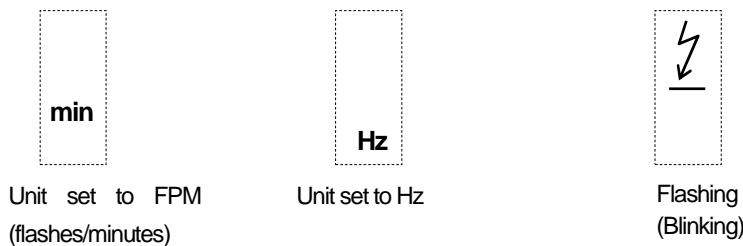

3.3.5 Setting project display

The following will be displayed, according to the mode of measure and *parameter settings



Internal flashing mode



ECO mode

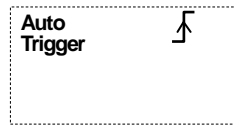

Positive auto trigger



Negative auto trigger



Set the measuring range in Parameter setting mode*



Set the flash time (duration)



Choose positive when set trigger edge in *Parameter setting mode



Choose negative when set trigger edge in *Parameter setting mode



Choose angle setting when delay set in *Parameter setting mode



Choose delay time when delay set in *Parameter setting mode

* Please see section 4.5 for Parameter setting data.

3.3.6 Battery Indication

Indicates remaining battery charge capacity in flashing operation mode.



Battery full



Battery diminished



Near zero

No battery indication while AC powered.

4 Function Instructions

4.1 Power on/off

Press "POWER" key to turn on unit. The unit will begin to flash in internal mode and the display will indicate the flash rate (FPM = flashes per minute).

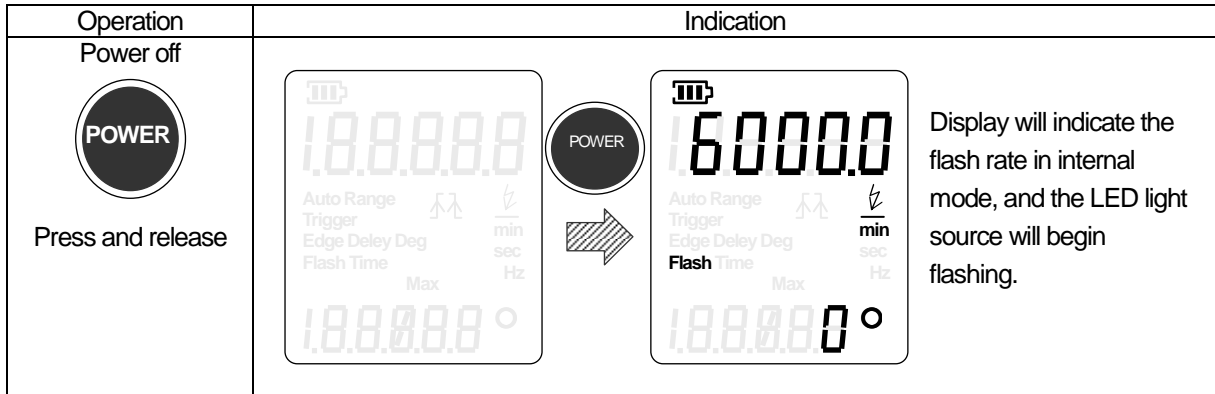

Press "POWER" key again to turn off unit. The display will turn off, and the device will stop flashing.

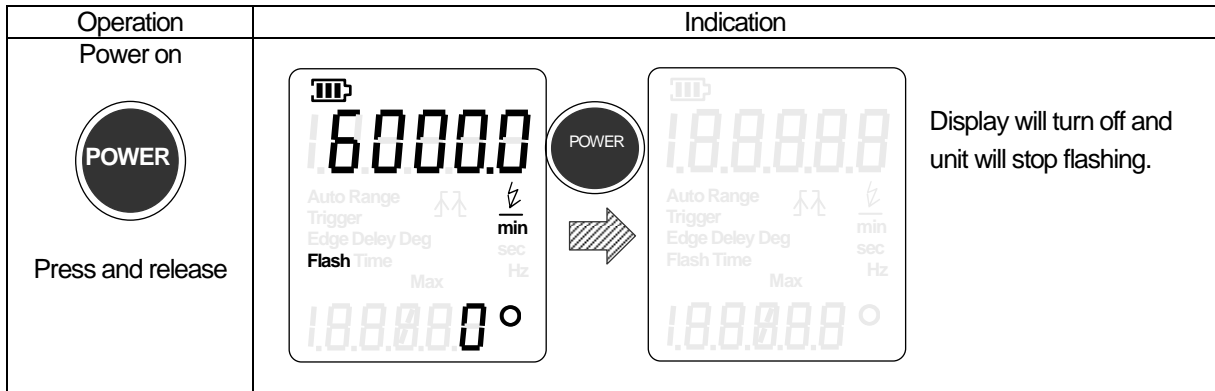

4.2 Mode Selection

Press and release "MODE" key to toggle between INTERNAL, EXTERNAL and PARAMETER mode.

*Refer to 4.5 "Parameter setting mode" for details.

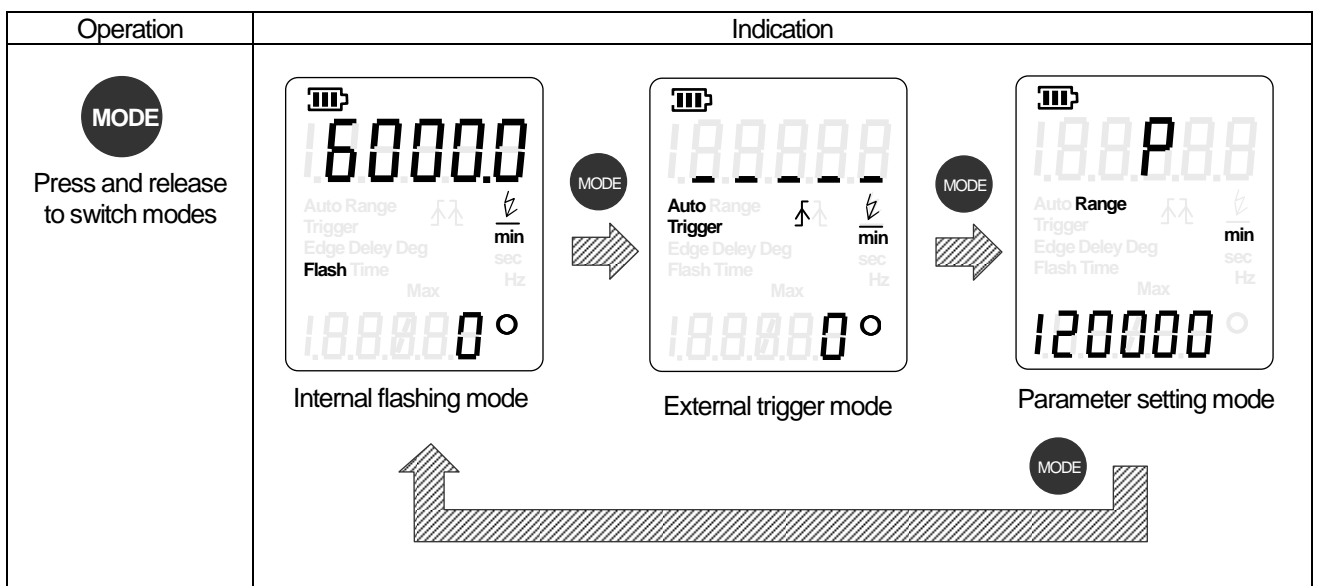

4.3 Internal flashing mode

4.3.1 Instruction for Internal flashing mode

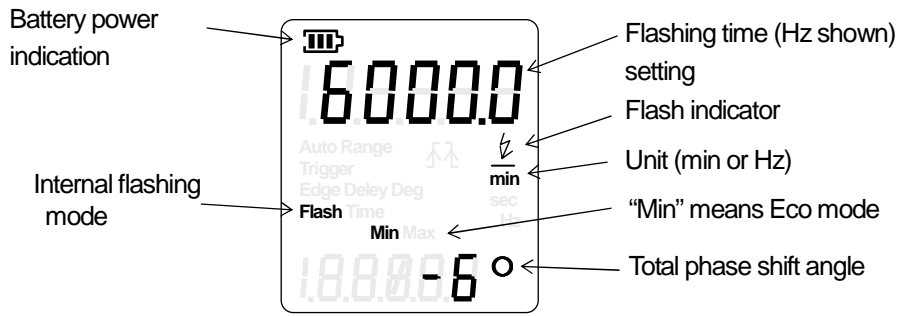

4.3.2 Changing Units of Measure in Internal Mode

Press and release "SET" key to toggle between FPM and Hz measuring unit.

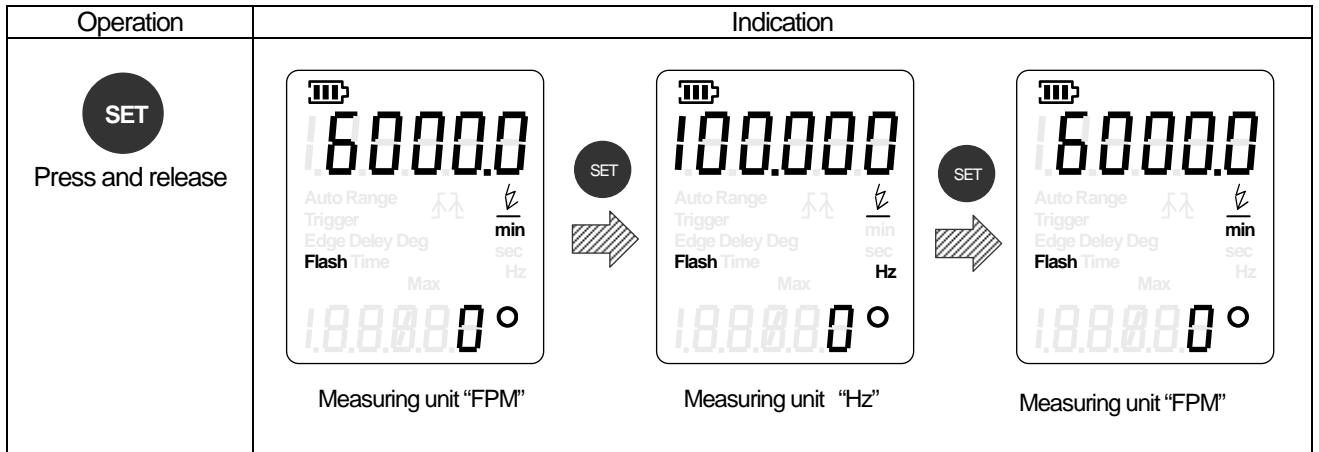

4.3.3 ECO function

Press and release "ECO" key to toggle between Normal and ECO nomy power save mode.

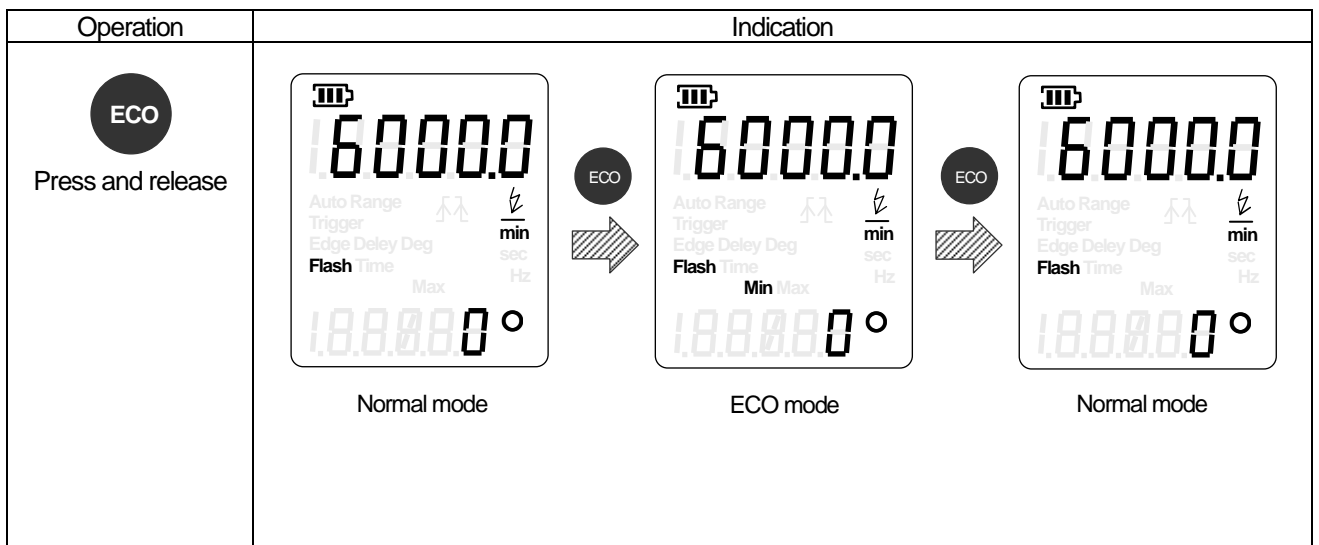

4.3.4 Flash rate and frequency “Internal Mode”

Set the flash rate (frequency) by turning the center dial.

Clockwise: Increase

Counter-clockwise: Decrease

For small adjustments, turn the dial slowly. For large adjustments, rotate the dial quickly.

The flash rate and resolution differs according to measuring range. Refer to section 4.5.1 for details.

Notes for setting the flash rate

One function of a stroboscope is to provide a “Frozen” virtual image of a rotating target once the flash rate of the stroboscope matches the rotational speed of the target object (FPM=RPM). The stroboscope will also show a single image when the flash rate or frequency is set to a lesser multiple of the RPM (1/2, 1/3, etc.) When the flash rate is increased to a high multiple (2, 3, etc.), multiple images will appear. To find the true RPM of the target object, begin by lowering the FPM to lower multiples until only a single image appears. For more information regarding the multiply/divide by 2 function, please see 4.3.5.

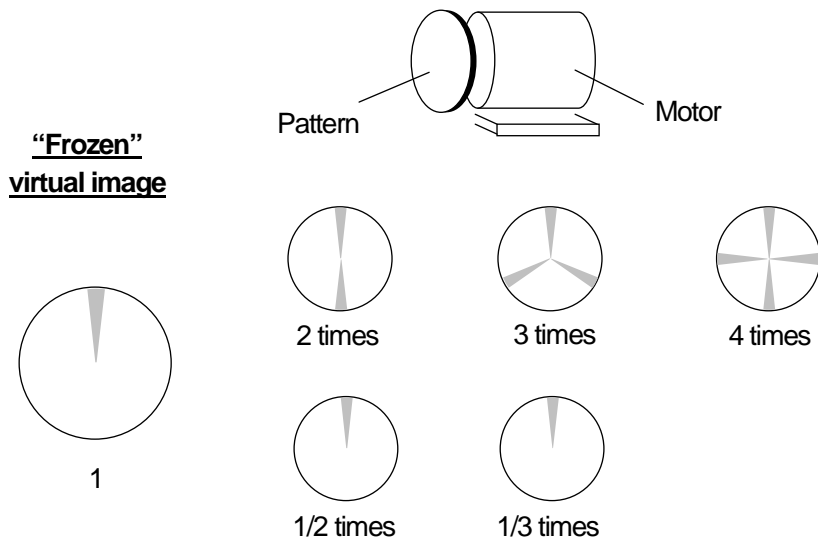

True rotational speed of target object (rpm)	Flash rate of stroboscope (FPM)	Multiple of true rotational speed	Number of stopped images
900	3600	4 times	4
	2700	3 times	3
	1800	2 times	2
	900	1 times	1
	450	1/2 times	1
	300	1/3 times	1

4.3.5 Multiply / Divide by 2 Function

The flash rate or frequency can be doubled or halved by the "x2" and "1/2" keys on the operation panel.

1) Doubling the flash rate (x2)

Press "x2" key to multiply the current flash rate by a factor 2 until the max flash rate is reached.

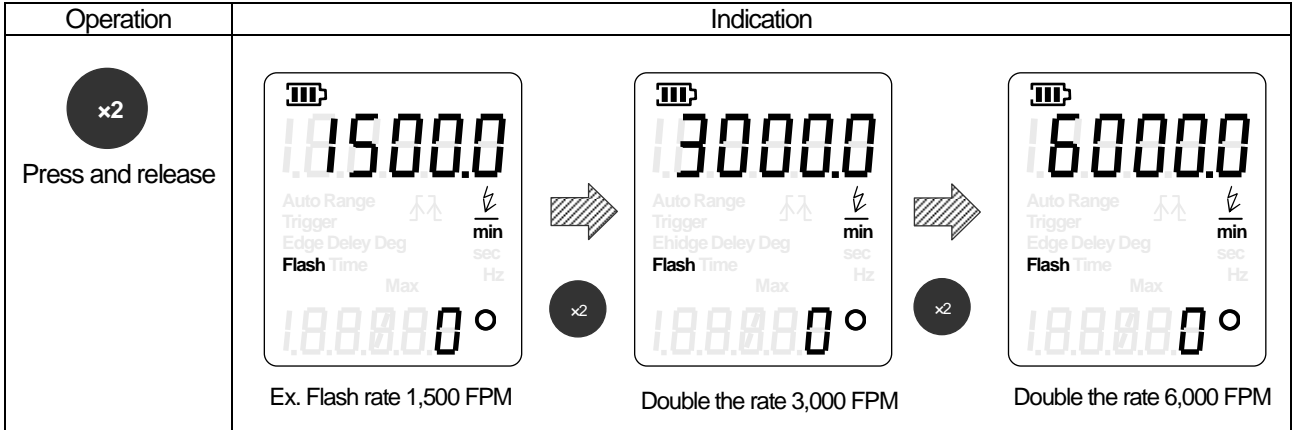

After the flash rate (frequency) changes, it becomes the new value based on the set display resolution. (See section 5. Specifications) Therefore, the frequency is not to return to the original frequency, even if "1/2" key is pressed after pressing "x2" key.

2) Halving the flash rate (1/2)

Press "1/2" key to divide the current flash rate by a factor of 2 until the min flash rate is reached.

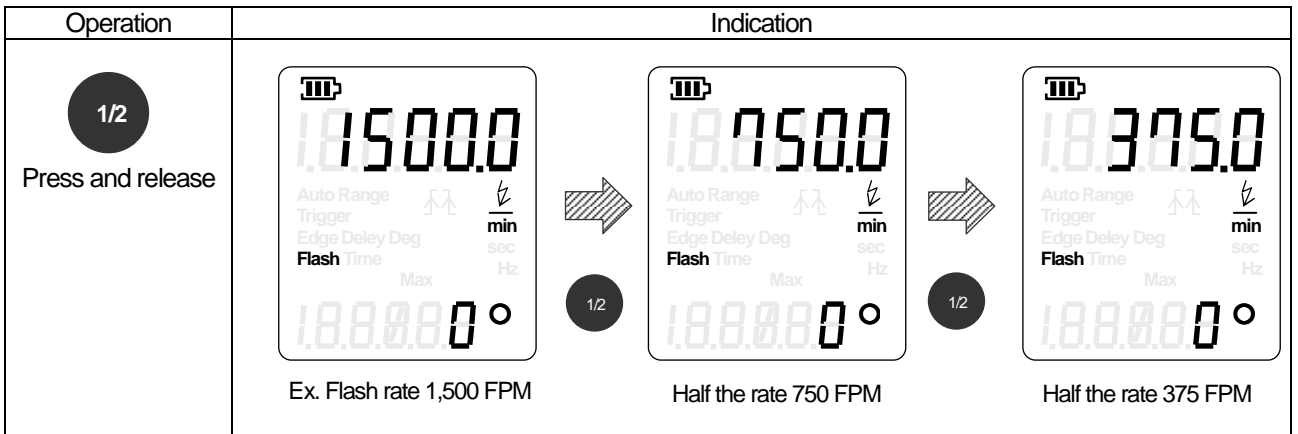

After the flash rate (frequency) changes, it becomes the value based on the set display resolution. (See section 5. Specifications) Therefore, the frequency is likely not to return to the original frequency even if "x2" key is pressed after pressing "1/2" key.

4.3.6 Phase Shift (Angle)

Once "Frozen" virtual image is achieved via FPM=RPM, the phase shift function can advance or delay the flash so that the image appears to be slowly rotating CW or CCW incrementally.

Press "PHASE+" key or "PHASE-" key to increment or decrement the phase shift by 3°.

The display will show the cumulative angle of the phase shift.

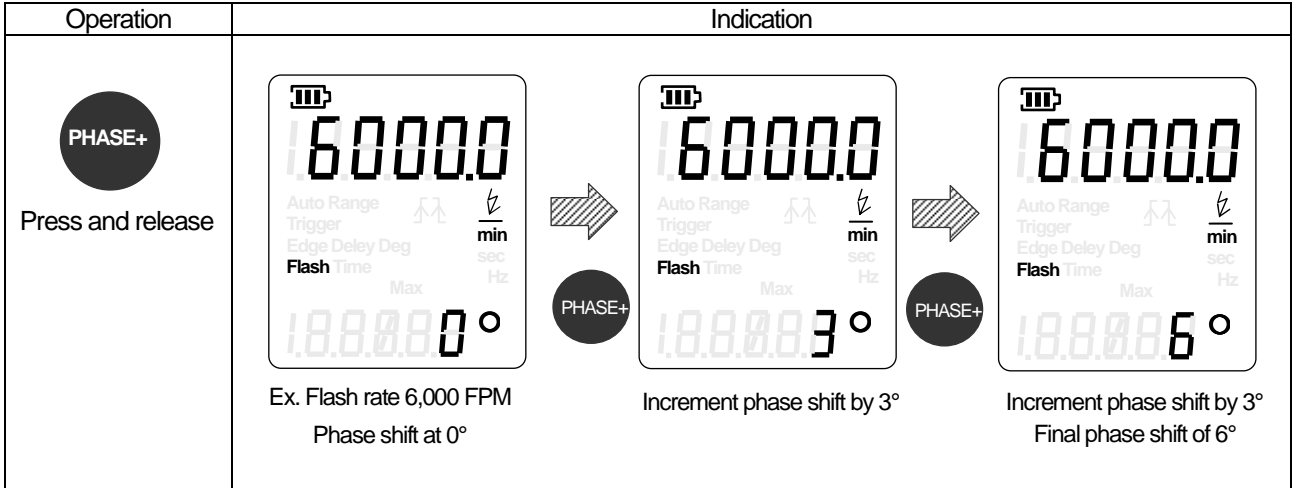

If "PHASE +" key is pressed at 357°, it becomes 0°.

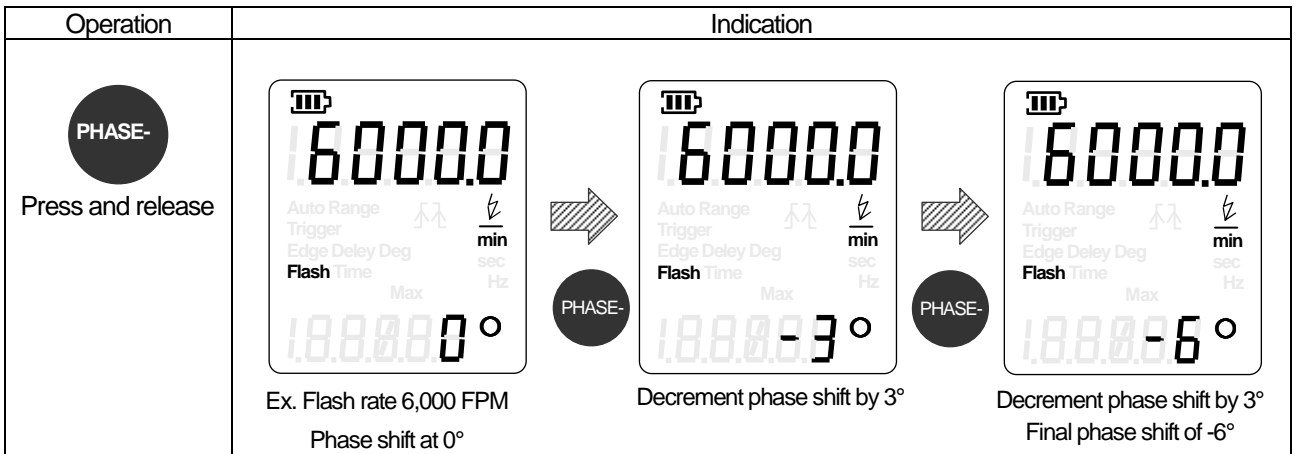

If "PHASE -" key is pressed at -357°, it becomes 0° .

4.3.7 Flash Pulse Duration (RATIO) setting





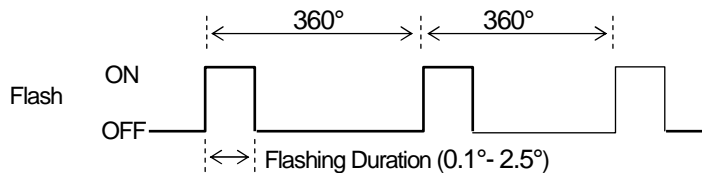

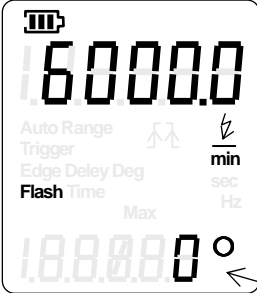

The RATIO can be set within the range of 0.1°/360° - 2.5°/360°, with a resolution of 0.1°.

Period of flashing = 360°

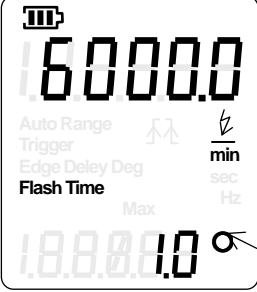
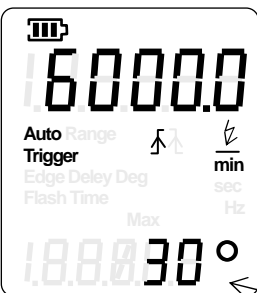

The Flash Pulse Duration (RATIO) is directly proportional to the LED brightness, which in turn, is inversely related to the target image focus.

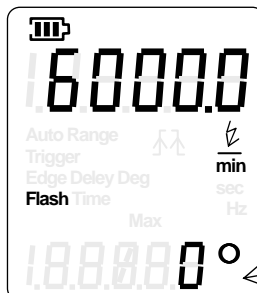

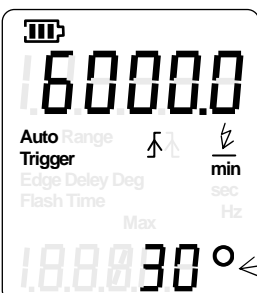



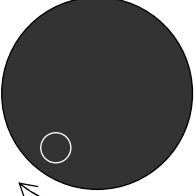

Press the "RATIO" key. The current mode will start blinking for 5 seconds allowing modification at this point.

Operation	Indication	
<p style="text-align: center;">  Press and release </p>	<p style="text-align: center;">Internal flashing mode</p>  <p style="text-align: center;">↓ </p> 	<p style="text-align: center;">External trigger mode</p>  <p style="text-align: center;">↓ </p> 
	<p>When blinking, flash duration can be modified (see next section for directions on this step)</p>	
	<p style="text-align: center;">** ↓ </p>  <p style="text-align: center;">Return to normal internal flashing mode and display</p>	<p style="text-align: center;">** ↓ </p>  <p style="text-align: center;">Return to normal external triggering mode and display</p>

** While in the flash pulse duration setting mode, a 5 second timer will bring the unit back to default normal mode, if no manual changes are made.

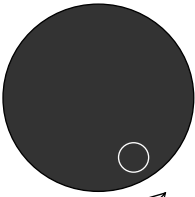
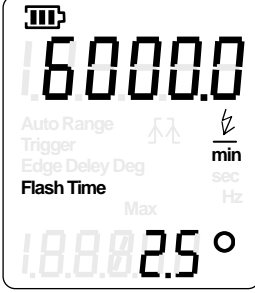
Press "PHASE+" key, or turn the dial clockwise direction to increment the Focus by 0.1°.

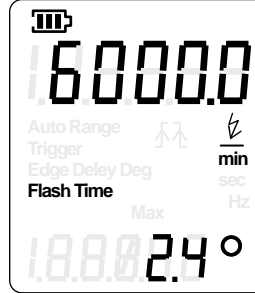
Press "PHASE-" key, or turn the dial counter clockwise direction to decrement the Focus by 0.1°.

Operation	Expression		
<p style="text-align: center;">PHASE+</p> <p style="text-align: center;">Press and release OR</p>  <p style="text-align: center;">Turn clockwise</p>	 <p style="text-align: center;">Flash duration (RATIO) 0.17/360°</p>	  <p style="text-align: center;">Incremented 0.27/360°</p>	<p style="text-align: center;">...</p>  <p style="text-align: center;">Maximum 2.57/360°</p>
<p style="text-align: center;">PHASE-</p> <p style="text-align: center;">Press and release OR</p>  <p style="text-align: center;">Turn counter clockwise</p>	 <p style="text-align: center;">Current (RATIO) 2.57/360°</p>	  <p style="text-align: center;">Decrementd 2.47/360°</p>	<p style="text-align: center;">...</p>  <p style="text-align: center;">Minimum 0.17/360°</p>

4.4 External Trigger Mode

This mode allows synchronization of the FPM with external signal input such as a sensor. See section 4.7 for details.

Parameter settings are possible, like phase shift, delay time, flash duration, edge trigger.

4.4.1 External trigger mode: LCD display information

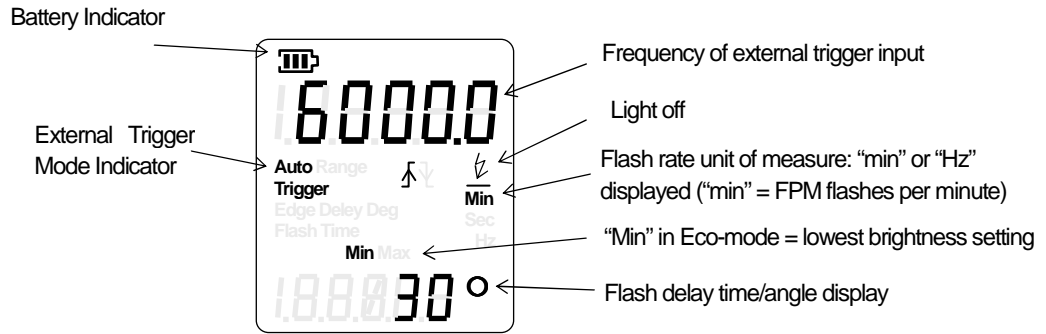

The frequency of the external signal is measured each period, while the latest external frequency measurement is updated every 50ms.

For an out of range external input signal, the display will appear as follows:



External signal < 60FPM/1Hz.

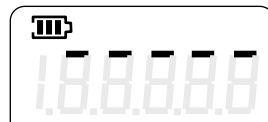

External signal > 10,000FPM/166Hz.

4.4.2 Flash Delay Setting

This mode allows for delayed flashing once an external signal is triggered.

The unit of delay is time (msec) or degree (°).

Press "PHASE+" or "PHASE-" key to toggle between two settings of "delay time" or "delay angle".

Operation button	Indication	
<p>PHASE+ PHASE-</p> <p>Press and release</p>	<p>"delay angle" in deg</p>	<p>"delay time" in ms</p>

4.4.2.1 “Delay time” setting

This can be set to 0~999 msec with a resolution of 1 ms.

The internal calculation time of the unit is 60us, which results in the actual delay time being (Setting delay time) + 60us.

The unit will begin flashing after the 1st trigger pulse as detected per timing chart below.

[Example]

Trigger: Positive edge (The instant where the delay time)

Delay time: 10ms (Independent of external input frequency)

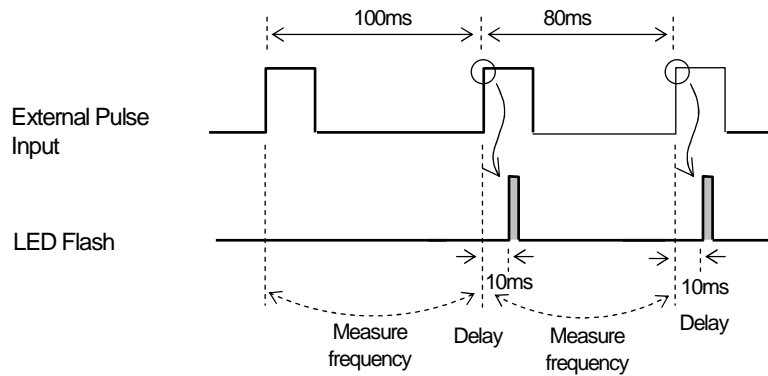

If external signal period < delay time, then the delay time value = 0.

Please note the built in 60us internal delay on top of the external signal input.

Press "PHASE+" key to select the delay time setting. Turn dial CW to increase and CCW to decrease.

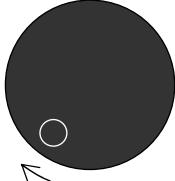
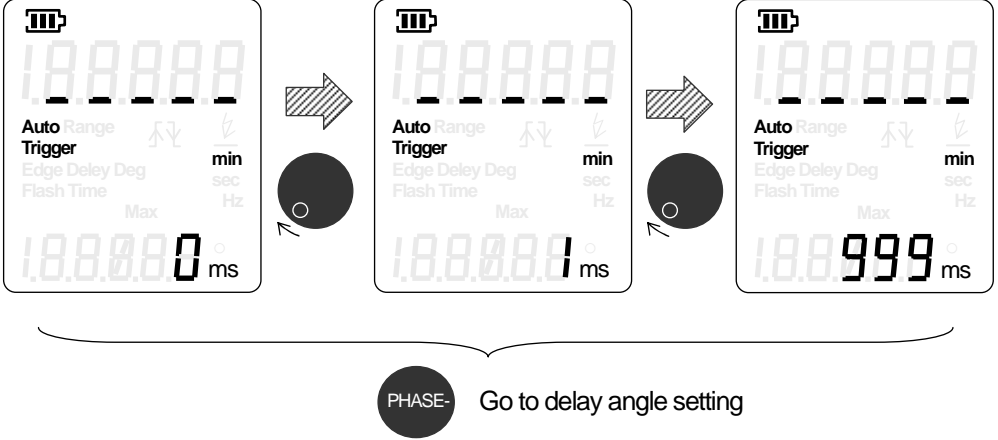
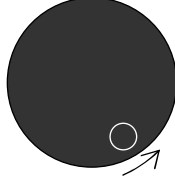
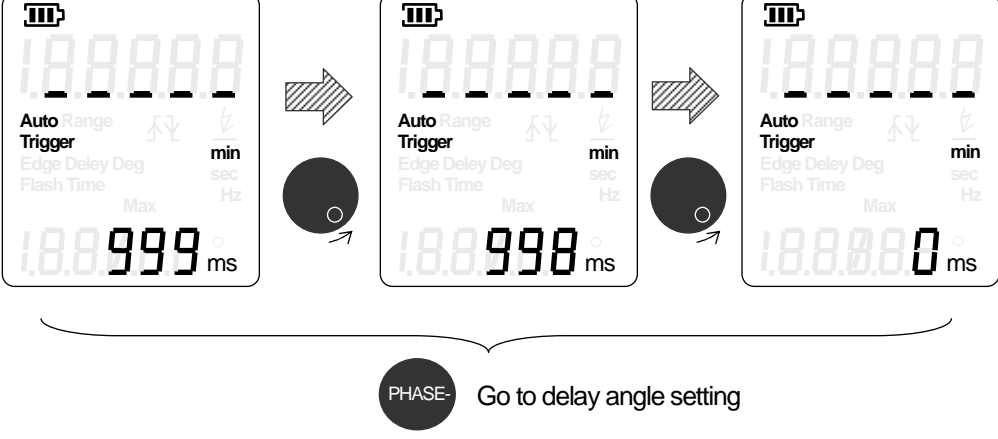
Button operation	Expression
 <p>Turn clockwise</p>	 <p>PHASE- Go to delay angle setting</p>
 <p>Turn counter clockwise</p>	 <p>PHASE- Go to delay angle setting</p>

4.4.2.2 “Delay angle” setting

Set the delay angle from 0° to 360° in 1° increment.

The actual delay time is as follows:

$$\frac{\text{Delay angle setting}}{360^\circ} \times \text{Period of External Input} + \text{approx. } 60\mu\text{s (Built-in)}$$

While the DT-326 does not flash at the 1st trigger pulse as shown below in the timing chart.

[Example]

Trigger: Positive edge

Delay angle: 36°

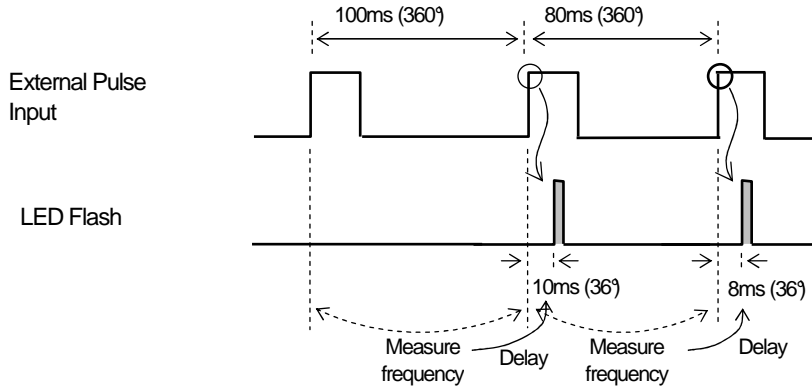

If the frequency of the external trigger input changes, the timing of the flash is inaccurate, because the timing is calculated based on the previous measured period.

If the current period of external trigger input is less than the previous period and the next trigger input occurs before the flash time, the delay angle setting is ignored and the unit flashes at delay angle = 0°.

Delay angle increases as the dial is rotated to the right. The angle settings will go to 0° when angle is past 359°.

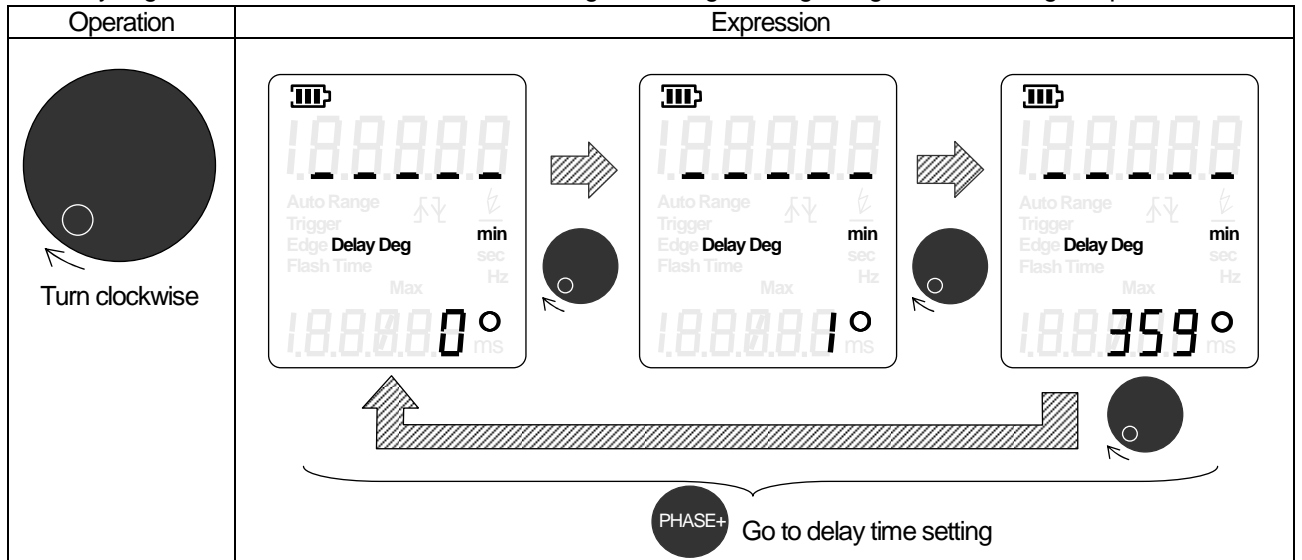

Delay Angle setting will decrease from 359°(Max) to 0°(Min) value for counter clockwise. The settings will eventually go to 0° as when angle decreases from 359°:

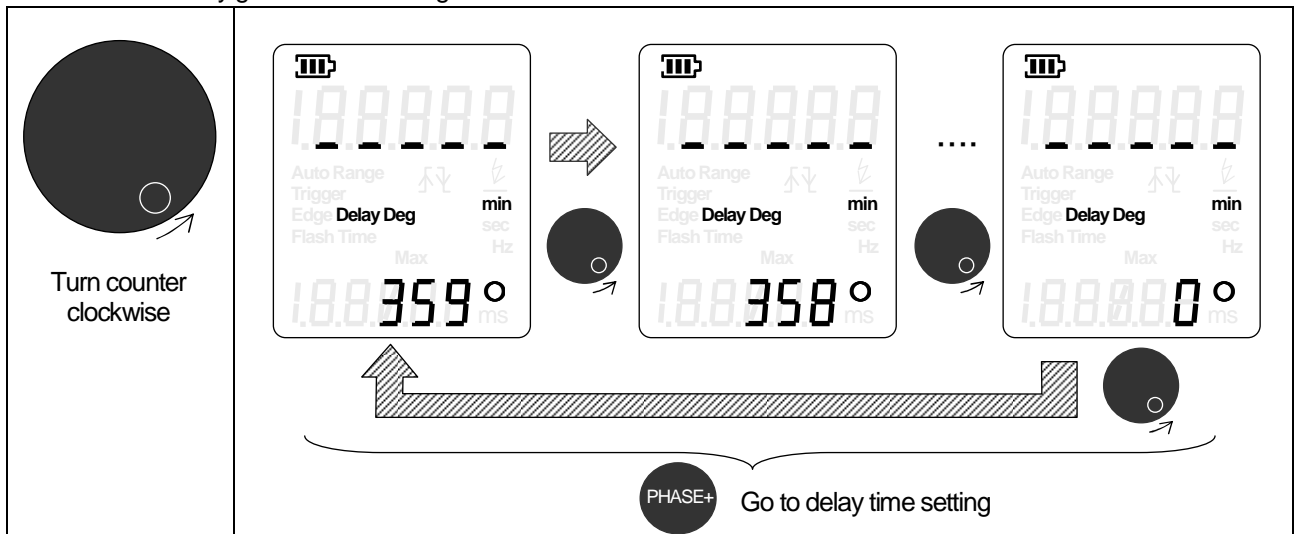

4.4.3 Units of Measure- Changing from FPM to Hz

Press and release the “SET” key to toggle between “FPM” to “Hz”.

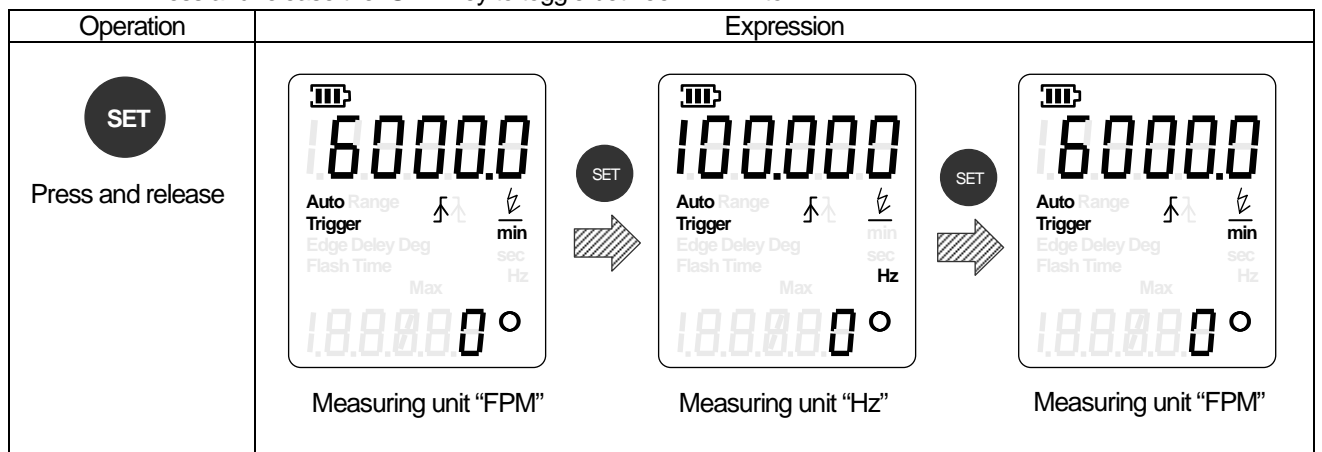

NOTE: Fraction values are rounded down.

4.4.4 ECO feature

Press and release the ECO key to reduce the brightness and conserve battery power. To return to original brightness, press and release the ECO key again.

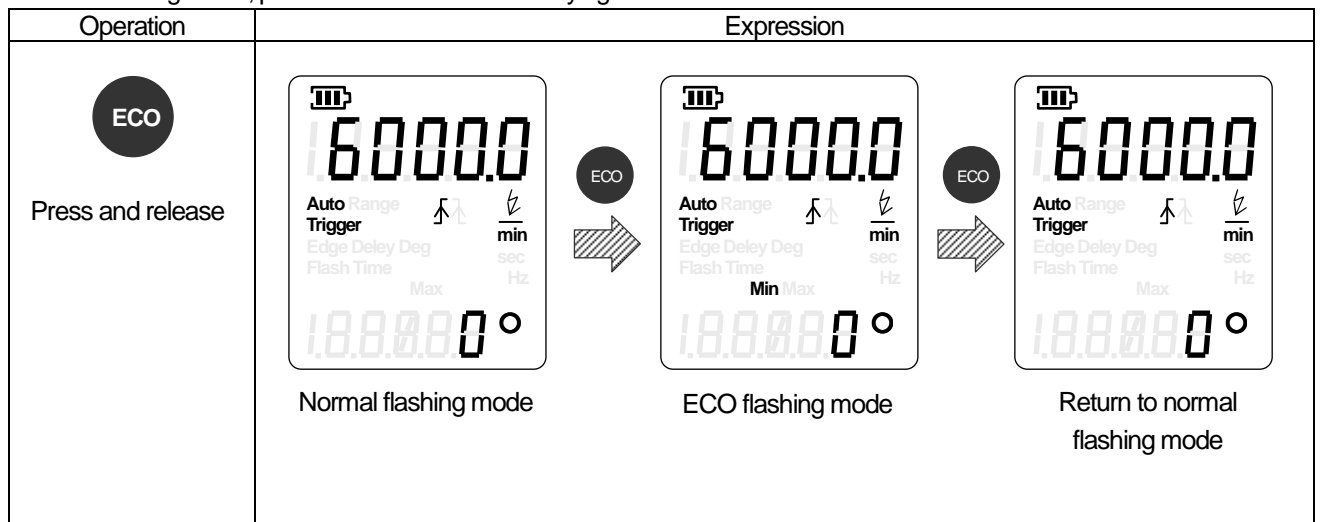

4.5 Parameter Setting Instruction

Press "MODE" until the LCD displays "P" (Parameter setting mode).

Press the "SET" key to cycle between the various parameter settings available (range, trigger edge, delay time, and LCD backlight). For more information regarding the various parameter settings, please refer to sections 4.5.2 through 4.5.4 below. Press the "MODE" key again to store the settings and return to measuring modes.

Note: "MODE" key must be pressed to store settings.

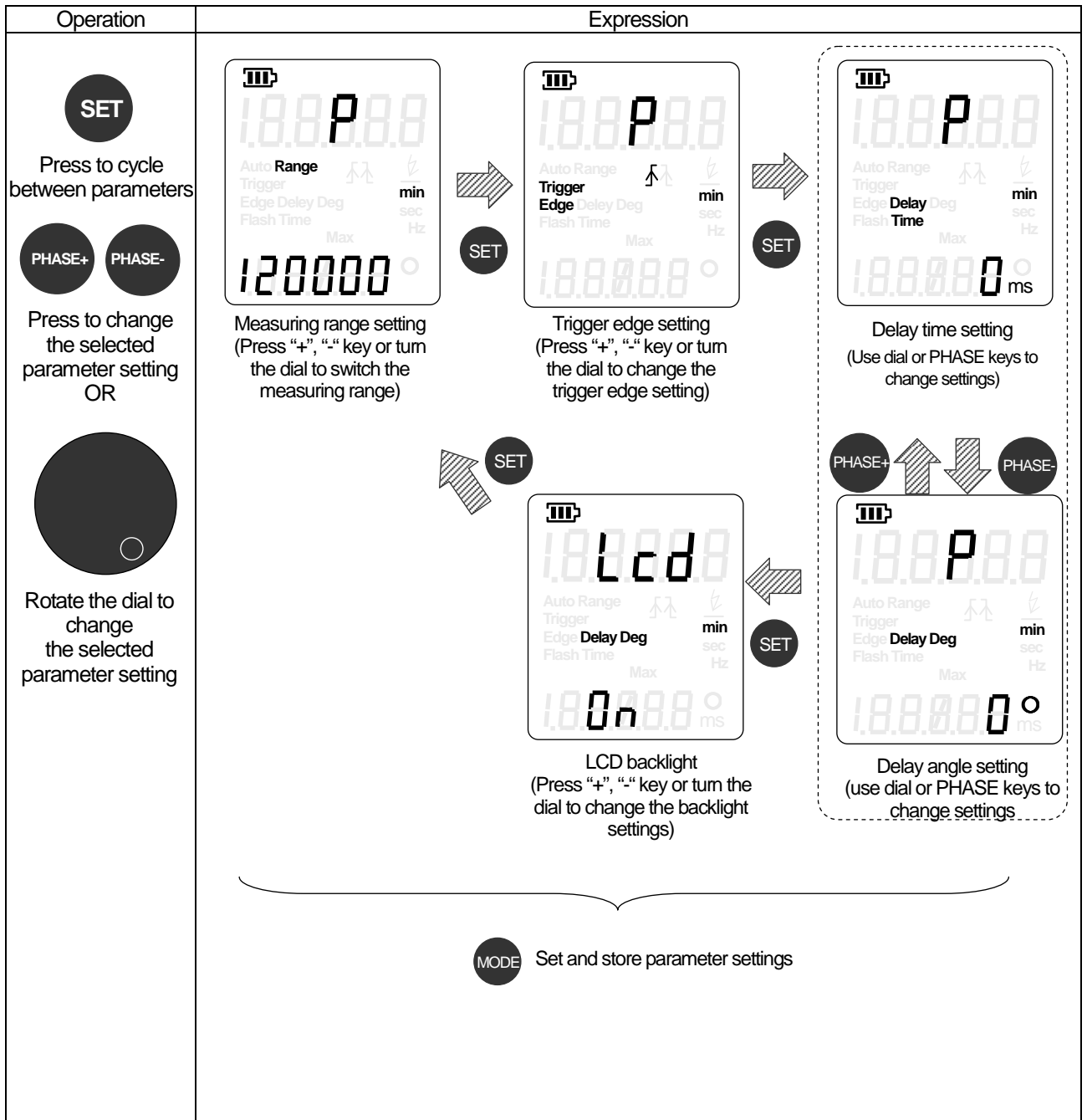

4.5.1 Measurement range setting

The DT-326 has a selectable measuring range, which can be set in the Parameter mode setting. The range and resolution of this setting will be different for each measuring range, as indicated in the table below.





Test unit	Measuring range as Indicated in Parameter Settings	
FPM	12,000 (range 60.0 - 12,000.0)	120,000 (range 60 - 120,000)
Hz	200 (range 1.000 - 200.00)	2,000 (range 1.00 - 2000.0)

*Note that if the flash range is changed to a lower range, the current flash rate, if larger than 12,000 FPM or 200 Hz, will decrease to the maximum allowable value of the range.

Ex: If flash rate is set to 60,000 FPM in the range of 60 – 120,000 FPM, it will automatically switch to 12,000 FPM when the flash measuring range parameter is changed to 60.0 – 12,000.0 FPM. The max value is limited if the Flashing time (frequency) setting is greater than the range in the test range switch.

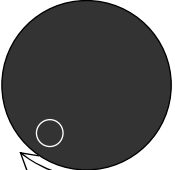
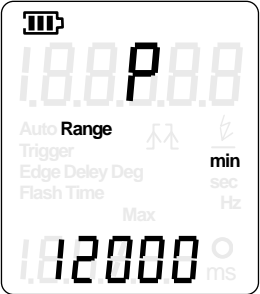
To adjust the measuring range parameter, press “PHASE +” or turn the dial clockwise to set the range as “120,000 FPM” or “2000 Hz”

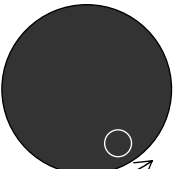
Press “PHASE -” or turn the dial counter clockwise to set the range as “12,000 FPM” or “200 Hz”.

Operation	Expression	
<p>PHASE+</p> <p>Press and release</p>  <p>Turn clockwise</p>	 <p>Measuring range set to “60.0 - 12,000.0 FPM”</p>	 <p>Measuring range set to “60 - 120,000 FPM”</p>
<p>PHASE-</p> <p>Press and release</p>  <p>Turn counter clockwise</p>	 <p>Measuring range set to “60 - 120,000 FPM”</p>	 <p>Measuring range set to “60.0 - 12,000.0 FPM”</p>

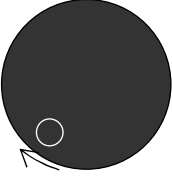
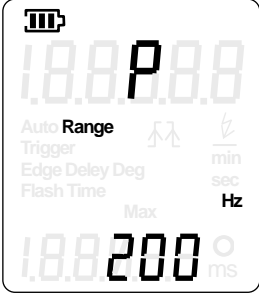
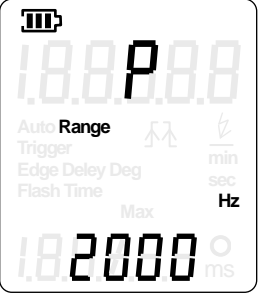
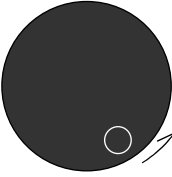
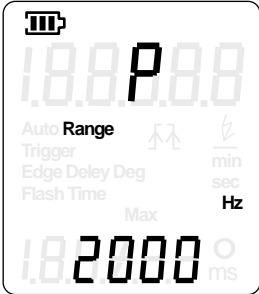
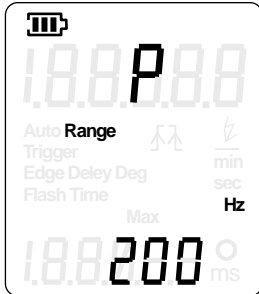
Operation	Expression	
<p data-bbox="304 293 400 360">PHASE+</p> <p data-bbox="261 387 459 414">Press and release</p>  <p data-bbox="280 645 443 672">Turn clockwise</p>	 <p data-bbox="507 611 758 678">Measuring range set to "1 – 200 Hz"</p>	 <p data-bbox="903 611 1153 678">Measuring range set to "1 – 2000 Hz"</p>
<p data-bbox="304 745 400 813">PHASE-</p> <p data-bbox="261 862 459 889">Press and release</p>  <p data-bbox="280 1102 443 1146">Turn counter clockwise</p>	 <p data-bbox="507 1059 758 1126">Measuring range set to "1 – 2000 Hz"</p>	 <p data-bbox="903 1059 1153 1126">Measuring range set to "1 – 200 Hz"</p>

4.5.2 Trigger Edge setting (External Mode)

Select Positive or Negative edge.

Examples:

-When trigger edge setting is set to "Positive Edge", the flash will occur on the leading edge of the input pulse (when delay setting is zero).

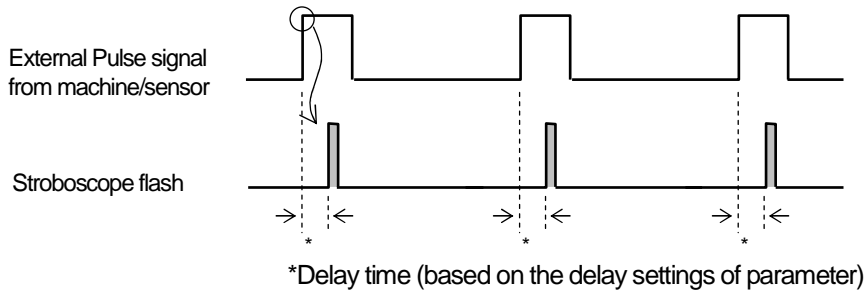

-When the trigger edge setting is set to "Negative Edge", the flash will occur on the trailing edge of the input pulse (when delay setting is zero).

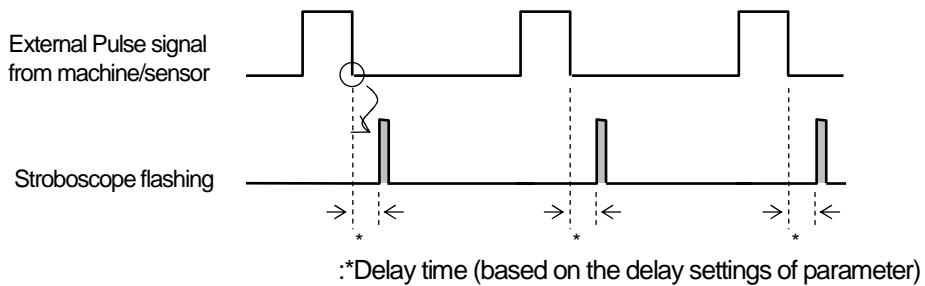

Press the "SET" key to cycle to the Trigger Edge setting parameter mode.

To set the trigger edge as "Down edge", press "PHASE -" key or turn the dial clockwise.

To set the trigger edge as "Up edge", press "PHASE +" key or turn the dial counter clockwise.

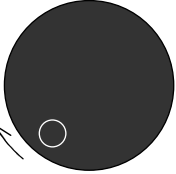
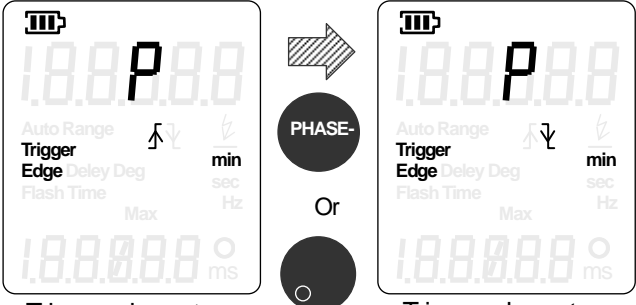
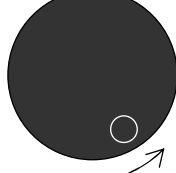
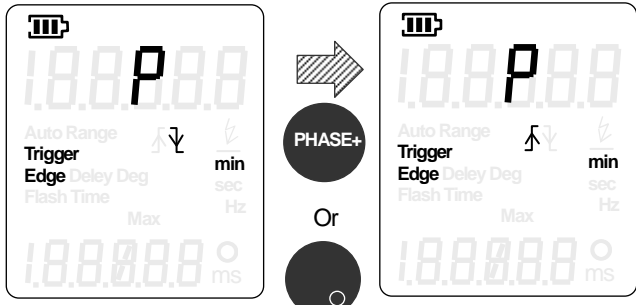
Operation	Expression
<p data-bbox="295 376 379 421">PHASE-</p> <p data-bbox="236 456 434 488">Press and release</p>  <p data-bbox="256 712 413 743">Turn clockwise</p>	 <p data-bbox="504 674 715 734">Trigger edge set as "Positive edge"</p> <p data-bbox="879 674 1090 734">Trigger edge set as "Negative edge"</p>
<p data-bbox="295 846 379 891">PHASE+</p> <p data-bbox="236 904 434 936">Press and release</p>  <p data-bbox="256 1160 413 1220">Turn counter clockwise</p>	 <p data-bbox="504 1122 715 1182">Trigger edge set as "Negative edge"</p> <p data-bbox="879 1122 1090 1182">Trigger edge set as "Positive edge"</p>

4.5.3 Delay setting

Delay time and angle setting will allow the flash to be delayed after an external pulse is sensed by the unit.

The Parameter setting mode:

Press “PHASE +” and “PHASE -” key, to select between delay time and delay angle.

4.5.3.1 Delay time setting

Selecting Delay time from an external pulse input to LED flashing can be set in the range of 0 – 999 msec, with a resolution of 1msec.

For details, please refers to “4.4.2 delay time setting”

Rotate the dial clockwise to increase delay time setting or counter clockwise to decrease the delay time.

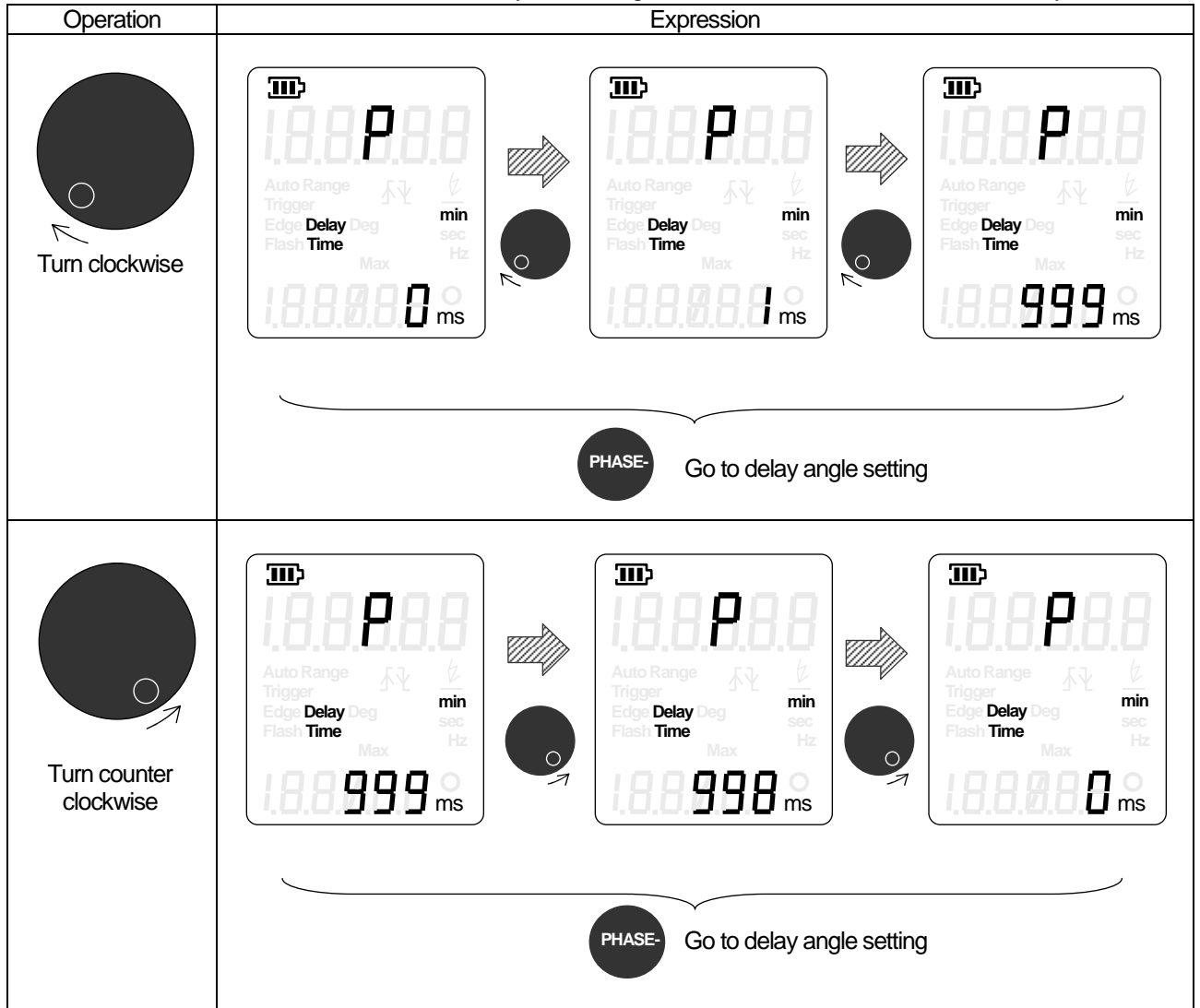

4.5.3.2 Delay angle setting

The delay angle can be set from 0° to 360° by 1° increments.

Delay angle setting increases as the dial turns right, and decreases as it turns left.

Delay angle events to zero when set below 0° (min) or 360° (max).

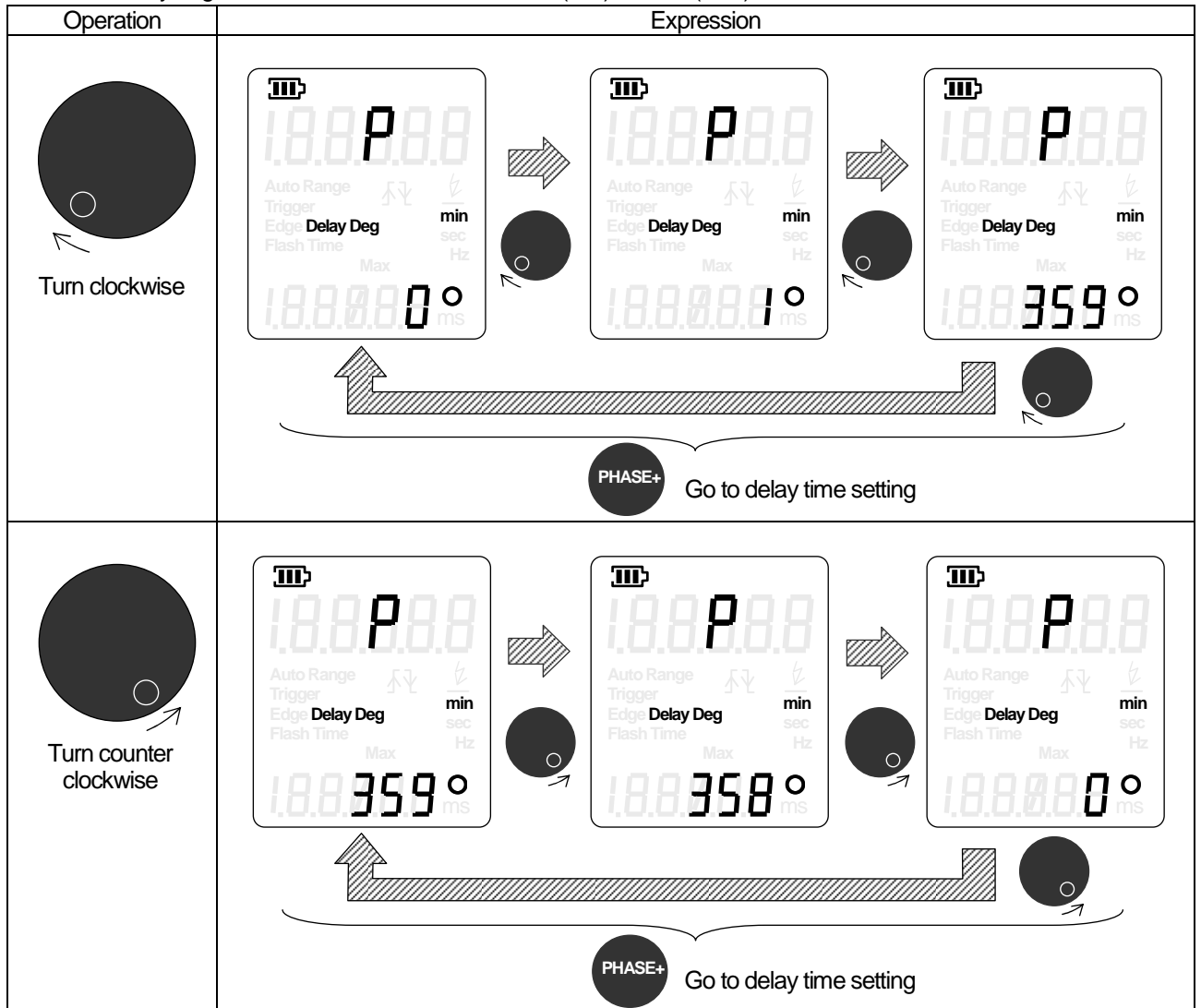

4.5.4 Back light setting

Press "SET" key in Parameter mode to enable this mode.

Turning off the backlight will conserve battery power. For more information regarding the automatic settings of the backlight, see section 4.6.

Press "PHASE +" key to turn on the backlight. Press "PHASE -" key to turn off the backlight

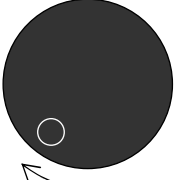
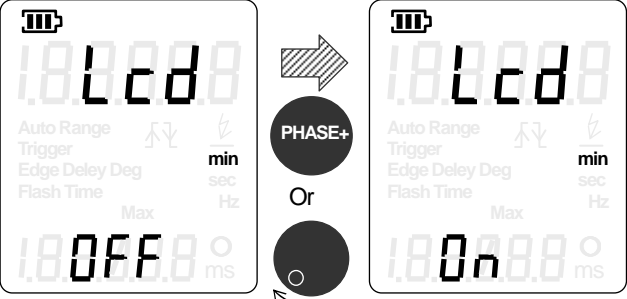
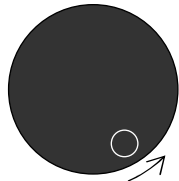
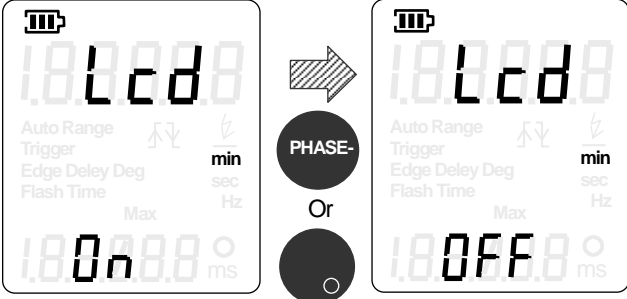
Button operation	Expression
<p>PHASE+</p> <p>Press and release OR</p>  <p>Turn clockwise</p>	 <p>LCD backlight OFF</p> <p>LCD backlight ON</p>
<p>PHASE-</p> <p>Press and release OR</p>  <p>Turn counter clockwise</p>	 <p>LCD backlight ON</p> <p>LCD backlight OFF</p>

4.6 Power-saving settings

4.6.1 LED flashing auto off

The LED flashing will automatically cease after 2 minutes of no keypad or dial operation when using battery power. Flashing will resume with either a dial (rotation) movement or a keypad operation.

The auto LED shutoff is disabled in External trigger mode, while a signal is being received by the unit.

The LED flashing will automatically cease after 2 minutes of missing pulse input.

4.6.2 Auto Power off

The power automatically shut off after 5 minutes of no keypad or dial operation when in battery power.

To resume operation, press "POWER" key.

The auto Power shutoff is disabled in External trigger mode, while a signal is being received by the unit.

The power will automatically shut off after 2 minutes of missing pulse input.

4.6.3 LCD back light off

The LCD backlight will automatically shut off after 2 minutes of no keypad or dial operation when using battery power. (With LCD parameter setting is "ON")

The LCD backlight will light again with keypad or dial operation.

4.7 Connector of External input/output

4.7.1 Connector specs and pin type

Pin No	Single name	Remarks
1	+12V	+12V power supply output
2	G12	Ground power supply output
3	TRG_IN	External pulse input
4	IN_COM	Universal interface of External pulse input
5	NC	(no connection)
6	NC	(no connection)
7	OUT	External pulse output
8	OUT_COM	Universal interface of External pulse output
9	NC	(no connection)
10	FG	Ground electrode of frame work

Connector type DT-326 side: 3260-10S3 (55) [HIROSE ELECTRIC CO., LTD.]

Accessory: 3240-10P-C [HIROSE ELECTRIC CO., LTD.]

4.7.2 External Pulse Input

The unit can be operated and controlled by an external signal, from either a sensor or a machine signal like an output from a printing press, re-winder or others. This will allow the stroboscope to flash in sync with the target object's rotational speed.

The input signal will have the following characteristics.

Input frequency: 60 - 10,000 FPM (1 - 160 Hz)

Input pulse width: over 50us

Delay angle: 0 - 359° (every 1°)

Delay time: 0 - 999ms (every 1ms)

Please connect with open collector output (below 1V (ON voltage)) or no-voltage contact output

(approx. 11mA current)

[Input circuit]

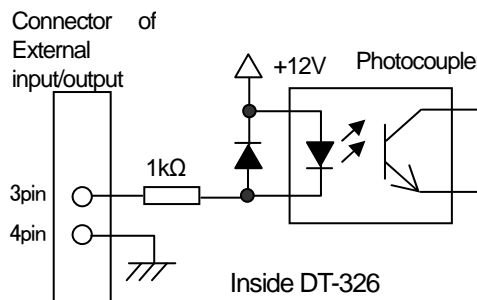

4.7.3 External pulse output

The unit will also output a signal that is related to the flash rate of the unit. This signal can be used to control additional stroboscopes so that each flashes at the same rate or to send a pulse to data collectors.

External circuit: Open collector output, Voltage below DC30V, Current below 30mA

Output pulse width: Approx. 200us

[Output circuit]

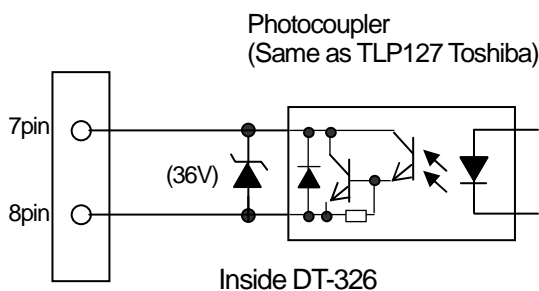

[Output time]

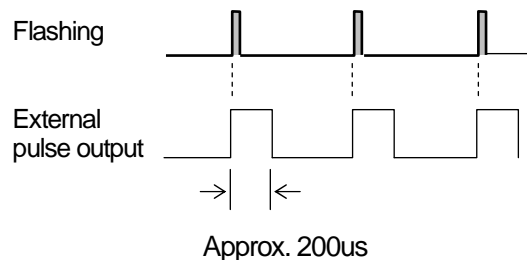

4.7.4 Option Cable- Input/ Output cable adaptor

Because the connector of the unit is not separate from input and output signal, the option cable adaptor separated I/O is provided for easy connection.

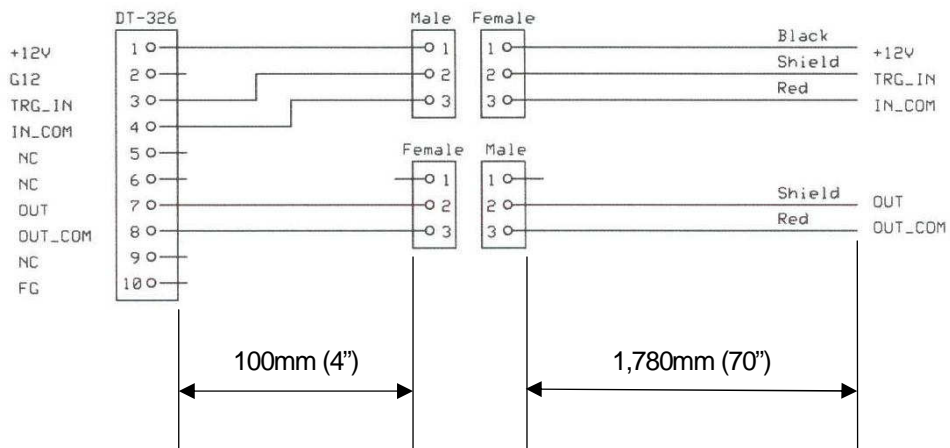
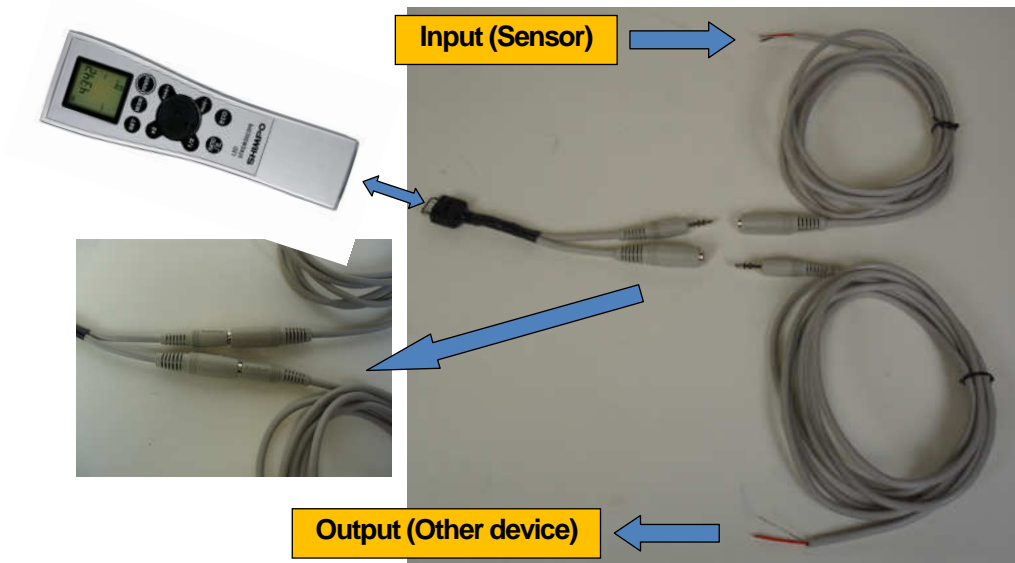

5 Specifications

Model Number			DT-326
Units of measure			FPM (flashes per minute) or Hz (frequency)
Measuring range			1 - 2,000Hz
			60 - 120,000 FPM
Accuracy			+/-0.02% (at 73°F [23°C])
Resolution of flash rate setting in internal mode	Unit; Hz	Measuring range: 1-200 Hz	0.01Hz
		Measuring range: 1-2000 Hz	0.1Hz
	Unit; FPM	Measuring range: 60 - 12,000 FPM	60.0 - 3,000.0 : 0.1 FPM 3,000.2 - 6,000.0 : 0.2 FPM 6,000.5 - 12,000.0 : 0.5 FPM
		Measuring range: 60 - 120,000 FPM	60 - 30,000 : 1 FPM 30,002 - 60,000 : 2 FPM 60,005 - 100,000 : 5 FPM 100,010 - 120,000 : 10 FPM
Flashing time (Duty)			0.1° - 2.5°/360° setting can be changed by 0.1° increments
Mode	Internal	Set and change flashing rate	Change flash rate by using dial, or "x2" and "1/2" key
		Phase Shift	Forward/backward by 3° increments
		Unit change	"FPM" or "Hz"
	External trigger	Flash rate (Input frequency)	1 – 166 Hz 60 – 10,000 FPM
		Input pulse width	More than 50 us
		Unit change	"FPM" or "Hz"
	Parameter setting	Measuring range	1 - 2000Hz (60 - 120,000 FPM) range or 1 - 200Hz (60 - 12,000 FPM)
		Trigger Edge	Positive or Negative edge
		Delay time/angle	Delayed time : 0 - 999ms *1 Delayed angle : 0 - 359°*1
		Back light	Selectable- ON or OFF
Power Saving Function	Flash (Auto off)	Stop flashing automatically after 2 min.	
	Back light (Auto off)	Turn off after 2 minutes of inactivity.	
	Power (Auto off)	Power off unit after approx. 5 minutes in stand-by mode	
Input/Output (I/F)	External Trigger Input	Photo Coupler Input, Current 12mA (approx.)	
	External Trigger output	Photo Coupler (Open collector) Output Voltage: DC30V or less, Current: 30mA or less, Pulse width: approx.200us	
	Sensor Power Supply	DC12V/max.40mA	

*1 Built-in delay time = 60us

Display		LCD	6 digits (main), 5 digits (sub) "LOW BAT", "Setting item", "Unit"
		Back light	Yellow green LED
		Flashing part	
Luminance (typ value) *2	Normal mode	20cm 6,000FPM	About 1300 lx
		50cm 6,000FPM	About 200 lx
	ECO mode	20cm 6,000FPM	About 400 lx
		50cm 6,000FPM	About 100 lx
Power supply		Battery	Alkaline AA battery (1.5Vx4pcs) *3
		AC adapter	DC5V / 2.0A
		Charge function	None
		Continuous Flashing *2	Approx. 20 minutes (Flashing with AA battery in normal mode) Approx. 80 minutes (Flashing with AA battery in ECO mode)
Temperature Range		32 - 95F [0 - 35°C]	
Operating humidity limits		35 – 38 % RH	
Use Environment		No dust, No corrosive gas	
Resistance of Environment		No water-proof/explosion protection and non-RoHS	
Standards		CE	
Weight		About 500g (include batteries)	
Housing Material		Aluminum	
Accessories		AC adapter Connection port for External output Carrying case, Alkaline AA battery (1.5Vx4pcs)	
Option Accessories		Input/ Output cable adaptor	

*2. Value of the new alkaline battery

*3. Ni-MH battery (1.2V X 4 pcs) is available.

6 Dimensions

