

Operation Manual



Warning

- When using the 6" wheel, do not use the extension shaft - the wheel may fly off the shaft and cause damage.
- Although the tachometer alone is able to achieve the higher ranges listed in the Range and Accuracy table on page 3, the wheel attachment has a maximum speed limitation of 5,000 FPM (for safety reasons).



DT-107A



DT-105A

The Series DT-100A Tachometer with microprocessor technology has heralded a superior standard in tachometer accuracy and capabilities for measuring and recording speeds of rotational, linear and surface plus total length. Offering unprecedented confidence, the DT-100A battery-operated tachometers feature the same rugged, high quality components that have made them the benchmark in the industry. These user-friendly, value-packed units feature memory storage; quick adjustment units knob; length functions; retrieval of last, maximum and minimum values; plus each unit comes standard with a free N.I.S.T. certificate. Units are available with an LCD or vibrant red LED display.

Incorporating the precise technology and user-friendly functions as the DT-100A, the DT-100A-S12 provides an exceptional accuracy in measuring speed and length via its 12" wheel. The larger wheel rotates more slowly than a standard 6" wheel, enabling reliable and safe registration of high speeds.

SPECIFICATIONS

Display Range: 0.10 - 25,000 RPM with floating decimal

Accuracy: ± 0.06 rpm: 0.10 - 999.9 rpm; ± 0.6 rpm: 1,000.0 - 9,999.9 rpm; $\pm 0.006\%$ of reading ± 1 digit (± 2 rpm max.) 25,000 rpm

Display: DT-105A: 5 digit 0.47" (12 mm) high LED; DT-107A: 5 digit 0.4" (10 mm) high LED

Measuring Units: Revolution: RPH, RPM; Feet: FPH, FPM; Miles: MPH; Yards: YPH, YPM; Inches: IPM; Meters: mPH, mPM; Length: m, cm, inches, feet, yards; Total Revolutions: REV

Memory System: 13 readings are stored in memory and retained for 5 minutes (last, max., min., and 10 extra measurements)

Detection: Optical coupler, 60 pulses/rev.

Update Time: 1 second (typical)

Over Range Indicator: Flashing numerals

Power Requirement: 2 AA 1.5V batteries (Life: Approx. DT-105A: 65 hrs.; DT-107A: 40 hrs.)

Operating Temperature: 32° - 113°F (0° - 45°C)

Construction: Die-cast aluminum housing

Product Weight: 0.9 lb (400 g)

Package Weight: Approx. 2 lb (0.91 kg)

Approvals: CE

Dimensions: 7.2" L x 2.4" W x 1.8"H (182.5 mm x 60 mm x 46 mm)

Warranty: 2-Year

Included Accessories: 2 cone adapters, funnel adapter, 3/8" extension shaft, carrying case, NIST certificate, master wheel (12" cir.)

SURFACE SPEED METRIC CONVERSION

Conversions such as YPM to mPM or mPM to YPM may be obtained from the memory only by switching from one mode to another.

OPERATION

1. Place adapter or wheel on shaft (as shown).

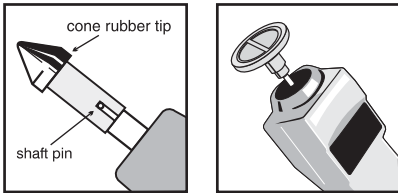

CAUTION: Do not attach master speed wheel on extension shaft. The wheel may slip off during measurement.

2. Turn selector switch to desired unit.

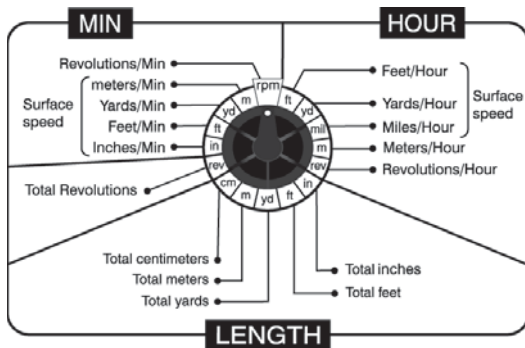

3. After attaching proper adapter or wheel, bring it into contact with rotating object or moving surface whose speed is to be measured. Apply only enough pressure to eliminate slip. The selected function will be shown "blinking" above the display digits.

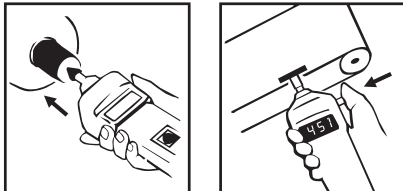

4. Press and hold the on-off switch. Display will update approximately every second.
5. Observe speed for as long as it is desired.
6. On-off switch must be released prior to removal of tachometer from rotating object if last reading must be captured.
7. After release of power switch, the last reading will be displayed for approximately 5 minutes. Readings will be retained in memory for 5 minutes and can be extended any number of additional 5 minute periods by re-pressing the memory switch.

MEMORY RECALL

Automatic Memory

The following are automatically stored in memory for 5 minutes following release of the power switch:

- Last reading
- Maximum reading
- Minimum reading

DT-105A:

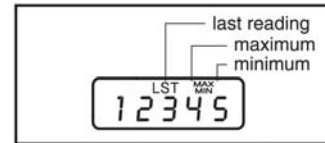

DT-107A

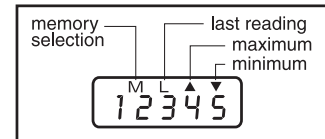

To fill all three memory spaces, unit must operate for about 5 seconds. If any of the above memory readings are missing, unit must operate a few seconds longer.

Memory Selection

The DT-100A has the capability of storing 10 extra readings in its memory. These readings can be obtained from the same machine or many machines (up to 10) by pressing the memory switch momentarily as the reading you wish stored appears on the display. An "M" with an integer will appear on the top of the display momentarily, and will be stored in memory. Up to 10 readings can be stored.

NOTE: All memory data will be erased if automatic shut-off has occurred. To recall a specific reading, press the memory switch until the desired reading shows up on the display along with its memory position. To erase all data from the memory, press the memory switch for at least 5 seconds until display shows CCCCC. If you hold the memory switch, the display will continue to show CCCCC until the switch is released, then will default to 0.00.

BATTERY REPLACEMENT

Low battery voltage is indicated by LO BAT on the display. Remove end cover by using a coin or appropriate screwdriver and replace both batteries. Please note polarity.

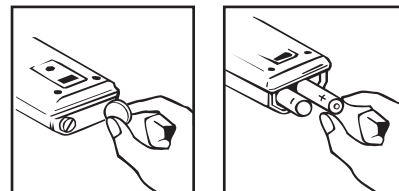

RANGE & ACCURACY

Using the 12" master wheel and proper mode selector switch, the following industrial units of measurement are achieved:

R: REVOLUTIONS	SINGLE RANGE	ACCURACY	RESOLUTION
Contact RPM (rev./min.)	0.1 - 999.99	± 0.06	0.01
	1,000.0 - 9,999.9	± 0.6	0.1
	10,000 - 25,000	±0.006% of reading ±1 digit (or ±2 rpm max.)	1
Contact RPH (rev./hour)	6 - 99,999	±0.006% of reading ±1 digit (or ±6 rpm max.)	1
REV (total revolution)	0.1 - 9,999.9	± 0.1	0.1
	10,000 - 99,999	± 1	1
F: FEET	SINGLE RANGE	ACCURACY	RESOLUTION
F/M (feet/min)	0.1 - 999.99	± 0.06	0.01
	1,000.0 - 9,999.9	± 0.6	0.1
	10,000 - 25,000	± 1	1
F/H (feet/hour)	6 - 99,999	±0.006% of reading ±1 digit (or ±6 FPH max.)	1
FT (length:feet)	0.02 - 999.98		0.02
	1,000.0 - 9,999.9		0.1
	10,000 - 99,999		1
Y: YARDS	SINGLE RANGE	ACCURACY	RESOLUTION
Y/M (yards/min.)	0.03 - 999.99	± 0.06	0.01
	1,000.0 - 8,333.3	± 0.3	0.1
	10,000 - 99,999	±0.006% of reading ±1 digit (or ±6 YPH max.)	1
Y/H (yards/hour)	2.0 - 9,999.9	±0.6	0.1
YRd (length:yard)	0.01 - 999.99		0.01
	1,000.0 - 9,999.9		0.1
	10,000 - 99,999		1
I: INCHES	SINGLE RANGE	ACCURACY	RESOLUTION
I/M (inches/min.)	1.2 - 9,999.9	±0.6	0.1
	10,000 - 99,999	±0.006% of reading ±1 digit (or ±6 IPM max.)	1
IN (length:inches)	0.2 - 9,999.8		0.2
	10,000 - 99,999		1
m: METERS	SINGLE RANGE	ACCURACY	RESOLUTION
m/M (meters/min.)	0.03 - 999.99	± 0.06	0.01
	1,000.0 - 7,620.0	± 0.3	0.1
	10,000 - 99,999	±0.006% of reading ±1 digit (or ±6 MPH max.)	1
m/H (meters/hour)	1.8 - 9,999.9	± 0.6	0.1
m (length:meter)	0.01 - 999.99		0.01
	1,000.0 - 9,999.9		0.1
	10,000 - 99,999		1
cm (length:centimeter)	0.5 - 9,999.5		0.5
	10,000 - 99,999		1
M: MILES	SINGLE RANGE	ACCURACY	RESOLUTION
M/H (miles/hour)	0.0011 - 9.9999	± 0.0006	0.0001
	10.000 - 99.999	± 0.006	0.001
	100.00 - 284.09	± 0.01	0.01

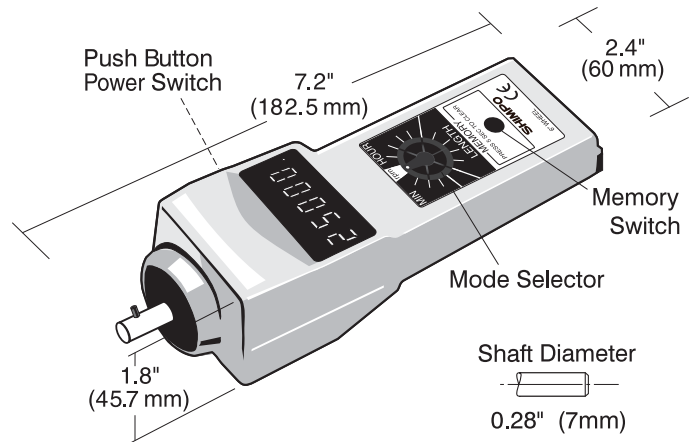

CAUTION: Although tachometer alone is able to achieve above ranges, the master wheel has a maximum speed limit of 5,000 FPM (for safety reasons).

NOTE: When using master wheel, accuracy can be affected as much as 0.3% of reading

DIMENSIONS

12" Circumference Wheel

